



Drum & Container Pumps

Corporate Profile



Distribution Center

Throughout our history we have been recognized for our commitment to product quality, customer care, and market knowledge. Headquartered outside Atlanta, Georgia USA, STANDARD PUMP, INC continues to build a global team of factory certified distributors which currently expands to fifty-eight countries.

STANDARD pumps are commonly used throughout the: Chemical Processing, Waste Water Treatment, Plating, Medical, Semi-Conductor, Agriculture, and Petroleum industries worldwide.

Our new state of the art 80,000 sq. ft (25,000 sq. meters) Production Facility enables STANDARD to meet or exceed the demands of the market by producing the highest quality product. In addition, all products undergo stringent quality control review during the molding process at our “turn-key” molding facility. All pumps are manufactured according to safety guidelines set forth by agencies such as Demko and Underwriter’s Laboratory in order to ensure the highest quality product and most importantly - your safety.



Molding Facility



Production Facility

Table of Contents

Quality Materials for Industrial Applications	4
Applications	5
Markets Served	6
Drum Pump Motors	7–8
CPVC Series	9
Polyvinylidenefluoride Series	10
Stainless Steel Series	11
Polypropylene Series	12
Polypropylene High Temperature Series	13
Pump Packages	14–15
Motor & Tube Assembly Detail	16
Accessories	17–18
Global Distribution	19

QUALITY MATERIALS FOR INDUSTRIAL APPLICATIONS

P Polypropylene is a high quality industrial strength plastic. Polypropylene is commonly used in a variety of industries, due to it's chemical resistance & durability.

Maximum Temperature:
130°F / 55°C

P Polyvinylidene fluoride (PVDF) is a high quality industrial strength plastic. PVDF is commonly used in applications where concentrated, aggressive liquids are present.

Maximum Temperature:
175°F / 80°C

H Hastelloy C is high grade metal used for a variety of applications requiring excellent strength and chemical resistance. Commonly used in applications requiring "intrinsically safe materials" while preventing chemical attack.

S Stainless steel 316 is a high quality metal typically used in applications involving solvent-based flammable liquids. In addition, stainless 316 is used in the food/beverage industry.

T Teflon® is a high quality plastic material that provides excellent chemical resistance and durability. In addition, Teflon® provides excellent heat deflection.

V Viton® is a quality material that provides chemical resistance. Viton® is an excellent choice for sealing applications throughout a variety of industries.

Applications



Drums & Barrels

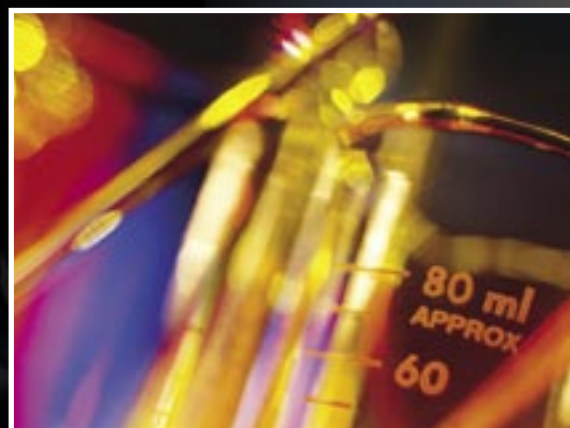

Laboratory



Large Storage Vessels



Small Storage Vessels

Markets Served



CHEMICAL PACKAGING



WASTE WATER TREATMENT



CHEMICAL MANUFACTURING

PLATING

SEMI-CONDUCTOR



PHARMACEUTICAL

AGRICULTURE

PETROLEUM



www.standardpump.com

Drum Pump Motors

Engineered for use in corrosive environments. Ideally suited for transferring acids and alkalis.

Model	Enclosure	Power	Watt	V.F.D
SP-ODP	O.D.P	115/1/50-60	450	No
SP-ODP-2	O.D.P	230/1/50-60	450	No

 Warning: Not Suitable For Pumping Flammable or Combustible Liquids
NOTE: V.F.D = Variable Frequency Drive

SP-ODP Series



Engineered for use in corrosive environments. Ideally suited for transferring acids and alkalis.



Model	Enclosure	Power	Watt	V.F.D
SP-280P	O.D.P (IP44)	115/1/50-60	825	No
SP-280P-V	O.D.P (IP44)	115/1/50-60	825	Yes
SP-280P-2	O.D.P (IP44)	230/1/50-60	825	No
SP-280P-2-V	O.D.P (IP44)	230/1/50-60	825	Yes

 Warning: Not Suitable For Pumping Flammable or Combustible Liquids
NOTE: V.F.D = Variable Frequency Drive

SP-280P Series



Engineered for use in heavily corrosive environments or when aggressive fumes are present. Ideally suited for transferring concentrated acids and alkalis.



Model	Enclosure	Power	Watt	V.F.D
SP-ENC	T.E.F.C (IP 54)	115/1/50-60	825	No
SP-ENC-V	T.E.F.C (IP 54)	115/1/50-60	825	Yes
SP-ENC-2	T.E.F.C (IP 54)	230/1/50-60	825	No
SP-ENC-2-V	T.E.F.C (IP 54)	230/1/50-60	825	Yes

 Warning: Not Suitable For Pumping Flammable or Combustible Liquids
NOTE: V.F.D = Variable Frequency Drive

SP-ENC Series



Drum Pump Motors

SP-400 Series



Engineered for use hazardous duty locations. Ideally suited for transferring flammable/combustible liquids.



Model	Enclosure	Power	Watt	V.F.D
SP-400-2	EXP	230/1/50-60	550	No
EEx de IIA T5 EN 50014				
E II 2 G EEx de IIA T6				

See warning at bottom of page.

SP-A2 Series



Engineered for hazardous duty locations or when air is the desired power source. Ideally suited for transferring flammable/combustible liquids.



Model	Consumption	Max. Inlet Pressure	Output
SP-A2	28 CFM@90 psi	100 psi	3/4 hp
	13.2 L/sec @ 6.2 bar	6.8 bar	560 w

See warning at bottom of page.

SP-A1 Series



Engineered for hazardous duty locations or when air is the desired power source. Ideally suited for transferring flammable/combustible liquids.



Model	Consumption	Max. Inlet Pressure	Output
SP-A1	22 CFM@90 psi	100 psi	1/2 hp
	10.4 L/sec @ 6.2 bar	6.8 bar	370 w

WARNING: Pumping of flammables or combustible liquids can generate a static electric discharge, causing fire or explosion resulting in injury or death. Read and understand operating instructions before starting this unit. Follow all federal, state and local safety codes including NFPA 30 - NFPA77. Prior to connecting to air supply, install bond and ground wires and check continuity of each wire. A meter reading of one ohm or less is required for safe liquid transfer. Use only metallic drum, receiving vessel and metallic pump (SP-SS) when pumping flammables. Air motors are not recognized under any current Underwriter's Laboratory listing program. Consult a qualified engineer for suitability for use in a hazardous area or on flammables.

CPVC Series

STANDARD's CPVC pump tube is engineered for transferring corrosive chemicals associated with the water treatment industry. Robust CPVC offers excellent durability and chemical resistance.

APPLICATIONS

- Sodium Hypochlorite ➤ Calcium Hydroxide ➤ Potassium Hydroxide
- Calcium Chloride ➤ Chlorinated Water ➤ Sodium Bromide

TECHNICAL DATA

Design: Seal-less / Centrifugal

Maximum Temp: 190°F/90°C

Viscosity: 1500 Cps/mPas (280, ENC, 400)
750 Cps/mPas (A-2, ODP)
450 Cps/mPas (A-1)

Wetted Materials: CPVC
Carbon
Hastelloy

Discharge Options: 1" (25mm) barb
3/4" (22mm) barb

Maximum Specific Gravity: 1.8

Model	Tube Assembly	Length	Shaft	Impeller
SP-CPVC-27	CPVC	27" (700 mm)	Hastelloy	High Volume
SP-CPVC-39	CPVC	39" (1000 mm)	Hastelloy	High Volume
SP-CPVC-47	CPVC	47" (1200 mm)	Hastelloy	High Volume
SP-CPVC-60	CPVC	60" (1500 mm)	Hastelloy	High Volume
SP-CPVC-72	CPVC	72" (1800 mm)	Hastelloy	High Volume
SP-CPVC-HH-27	CPVC	27" (700 mm)	Hastelloy	High Pressure
SP-CPVC-HH-39	CPVC	39" (1000 mm)	Hastelloy	High Pressure
SP-CPVC-HH-47	CPVC	47" (1200 mm)	Hastelloy	High Pressure
SP-CPVC-HH-60	CPVC	60" (1500 mm)	Hastelloy	High Pressure
SP-CPVC-HH-72	CPVC	72" (1800 mm)	Hastelloy	High Pressure

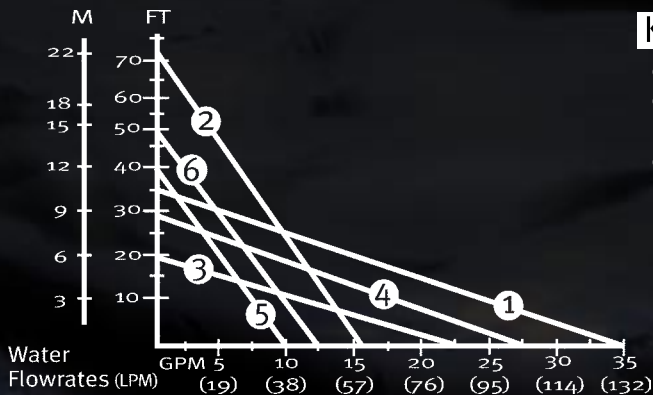

KEY:

- ① 280, ENC, 400/High Volume Tube
- ② 280, ENC, 400/High Pressure Tube
- ③ A-1/High Volume Tube
- ④ A-2, ODP/High Volume Tube
- ⑤ A-1/High Pressure Tube
- ⑥ A-2, ODP/High Pressure Tube

⚠ Not suitable for pumping flammable or combustible liquids

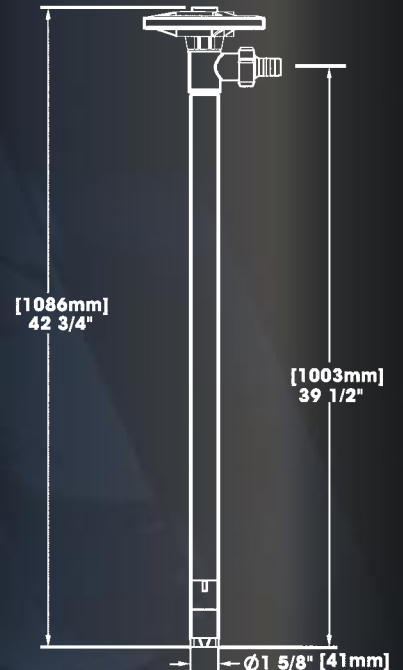

Polyvinylidenefluoride Series

STANDARD's PVDF pump tube is engineered for transferring highly concentrated aggressive liquids. Robust PVDF offers excellent durability and chemical resistance.

APPLICATIONS

- Concentrated Nitric Acid
- Sulfuric Acid-66 Baume
- Sodium Hypochlorite
- Hydrofluoric Acid
- Propionic Acid
- Stearic Acid

TECHNICAL DATA

Design: Seal-less / Centrifugal

Maximum Temp: 175°F/80°C

Viscosity: 1500 Cps/mPas (280, ENC, 400)
750 Cps/mPas (A-2, ODP)
450 Cps/mPas (A-1)

Wetted Materials: PVDF
Carbon
Hastelloy

Discharge Options: 1" (25mm) barb
3/4" (22mm) barb

Maximum Specific Gravity: 1.8

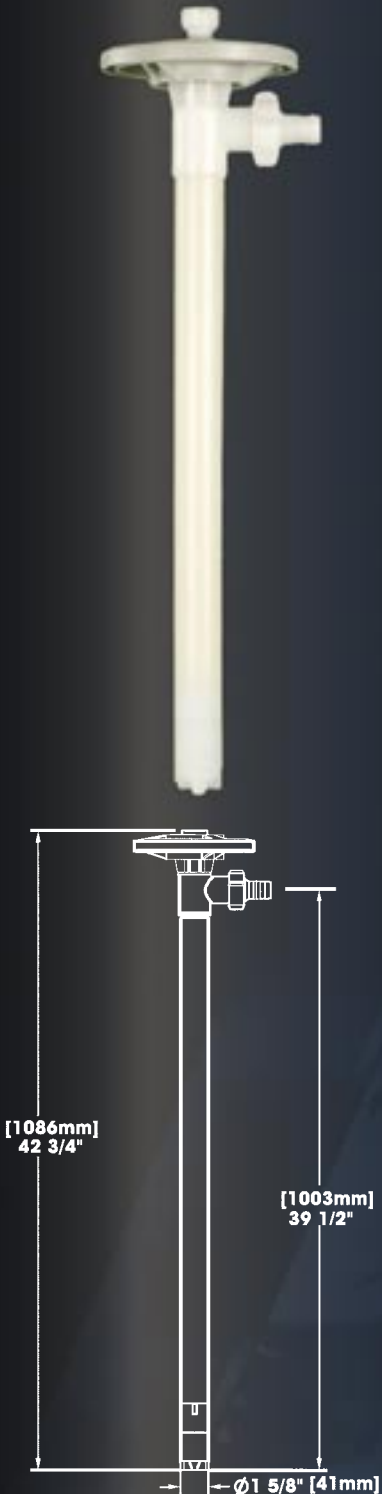

Model	Tube Assembly	Length	Shaft	Impeller
SP-PVDF-27	PVDF	27" (700 mm)	Hastelloy	High Volume
SP-PVDF-39	PVDF	39" (1000 mm)	Hastelloy	High Volume
SP-PVDF-47	PVDF	47" (1200 mm)	Hastelloy	High Volume
SP-PVDF-HH-27	PVDF	27" (700 mm)	Hastelloy	High Pressure
SP-PVDF-HH-39	PVDF	39" (1000 mm)	Hastelloy	High Pressure
SP-PVDF-HH-47	PVDF	47" (1200 mm)	Hastelloy	High Pressure

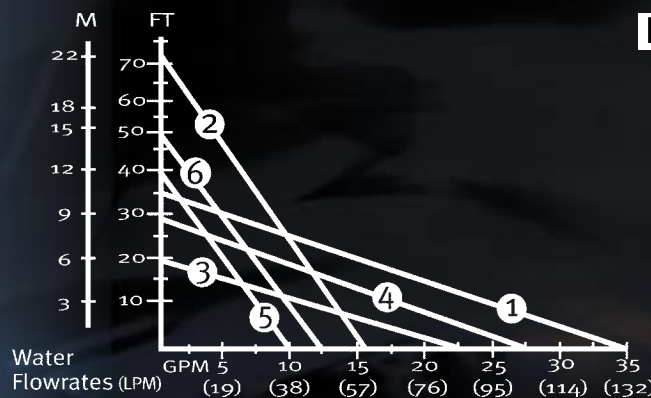

KEY:

- ① 280, ENC, 400/High Volume Tube
- ② 280, ENC, 400/High Pressure Tube
- ③ A-1/High Volume Tube
- ④ A-2, ODP/High Volume Tube
- ⑤ A-1/High Pressure Tube
- ⑥ A-2, ODP/High Pressure Tube

Warning: Not suitable for pumping flammable or combustible liquids

Stainless Steel Series

STANDARD's Stainless pump tube is engineered for transferring flammable and combustible liquids. Robust Stainless Steel 316 offers excellent strength and durability.

APPLICATIONS

- Alcohol
- Gasoline
- Aqueous Ammonia
- Isopropyl Ether
- Solvents
- Petroleum Products

TECHNICAL DATA

Design: Seal-less / Centrifugal

Maximum Temp: 175°F/80°C

Viscosity: 1500 Cps/mPas (280, ENC, 400)
750 Cps/mPas (A-2, ODP)
450 Cps/mPas (A-1)

Wetted Materials: Stainless 316
Carbon
Teflon

Discharge Options: 1" (25mm) barb
3/4" (22mm) barb

Maximum Specific Gravity: 1.8



Model	Tube Assembly	Length	Shaft	Impeller
SP-SS-27	Stainless	27" (700 mm)	Stainless	High Volume
SP-SS-39	Stainless	39" (1000 mm)	Stainless	High Volume
SP-SS-47	Stainless	47" (1200 mm)	Stainless	High Volume
SP-SS-60	Stainless	60" (1500 mm)	Stainless	High Volume
SP-SS-72	Stainless	72" (1800 mm)	Stainless	High Volume
SP-SS-HH-27	Stainless	27" (700 mm)	Stainless	High Pressure
SP-SS-HH-39	Stainless	39" (1000 mm)	Stainless	High Pressure
SP-SS-HH-47	Stainless	47" (1200 mm)	Stainless	High Pressure
SP-SS-HH-60	Stainless	60" (1500mm)	Stainless	High Pressure
SP-SS-HH-72	Stainless	72" (1800 mm)	Stainless	High Pressure

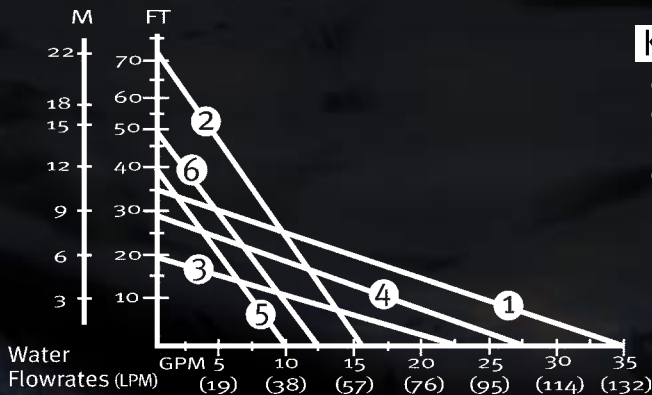
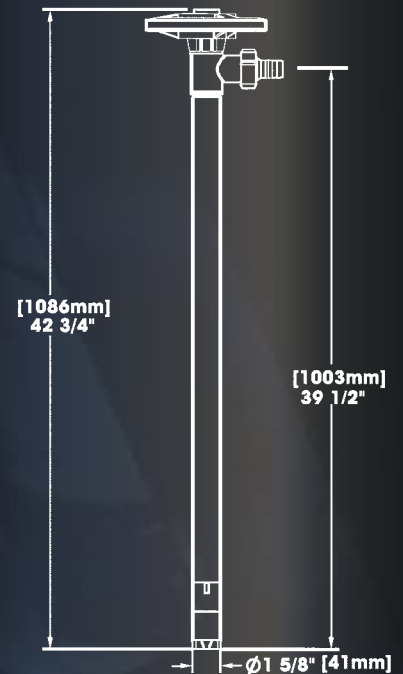

KEY:

- ① 280,ENC, 400/High Volume Tube
- ② 280,ENC, 400/High Pressure Tube
- ③ A-1/High Volume Tube
- ④ A-2, ODP/High Volume Tube
- ⑤ A-1/High Pressure Tube
- ⑥ A-2, ODP/High Pressure Tube

Warning: When pumping flammable or combustible liquids pump tube must be used in conjunction with an explosion proof motor.

Polypropylene Series

STANDARD's Polypropylene pump tube is engineered for transferring corrosive liquids. Robust Polypropylene ensures chemical resistance against light to mildly aggressive media.

APPLICATIONS

- Acetic Acid
- Sulfuric Acid
- Hydrochloric - 20%
- Nitric Acid - 20%
- Alkalies
- Ferric Chloride

TECHNICAL DATA

Design: Seal-less / Centrifugal

Maximum Temp: 130°F/55°C

Viscosity: 1500 Cps/mPas (280, ENC, 400)
750 Cps/mPas (A-2, ODP)
450 Cps/mPas (A-1)

Wetted Materials: Polypropylene
Carbon
Hastelloy

Discharge Options: 1" (25mm) barb
3/4" (22mm) barb

Maximum Specific Gravity: 1.8

Model	Tube Assembly	Length	Shaft	Impeller
SP-PP-27	Polypropylene	27" (700 mm)	Hastelloy	High Volume
SP-PP-39	Polypropylene	39" (1000 mm)	Hastelloy	High Volume
SP-PP-47	Polypropylene	47" (1200 mm)	Hastelloy	High Volume
SP-PP-60	Polypropylene	60" (1500 mm)	Hastelloy	High Volume
SP-PP-72	Polypropylene	72" (1800 mm)	Hastelloy	High Volume
SP-PP-HH-27	Polypropylene	27" (700 mm)	Hastelloy	High Pressure
SP-PP-HH-39	Polypropylene	39" (1000 mm)	Hastelloy	High Pressure
SP-PP-HH-47	Polypropylene	47" (1200 mm)	Hastelloy	High Pressure
SP-PP-HH-60	Polypropylene	60" (1500mm)	Hastelloy	High Pressure
SP-PP-HH-72	Polypropylene	72" (1800 mm)	Hastelloy	High Pressure

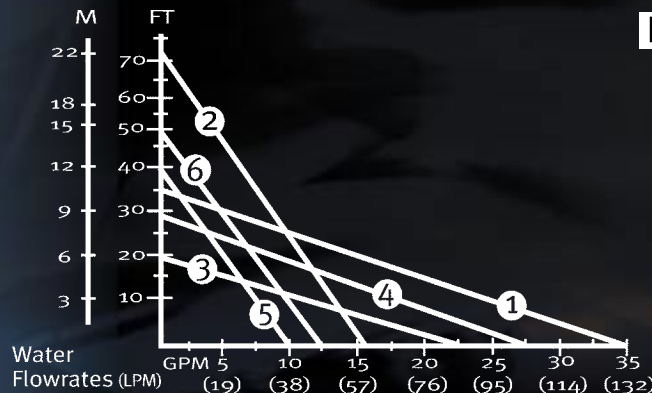
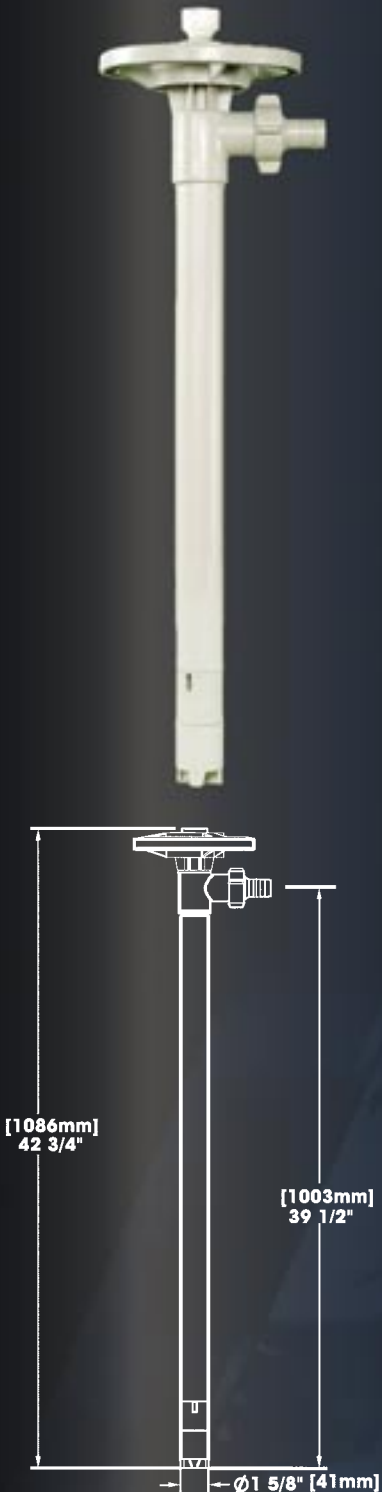

KEY:

- ① 280,ENC, 400/High Volume Tube
- ② 280,ENC, 400/High Pressure Tube
- ③ A-1/High Volume Tube
- ④ A-2, ODP/High Volume Tube
- ⑤ A-1/High Pressure Tube
- ⑥ A-2, ODP/High Pressure Tube

Warning: Not suitable for pumping flammable or combustible liquids

Polypropylene High Temperature Series

STANDARD's Polypropylene (PHT) pump tube is engineered for transferring high temperature corrosive liquids. Robust Polypropylene ensures chemical resistance and excellent heat deflection against light to mildly aggressive media.

APPLICATIONS

- Acetic Acid
- Sulfuric Acid
- Hydrochloric - 20%
- Nitric Acid - 20%
- Alkalies
- Ferric Chloride

TECHNICAL DATA

Design: Seal-less / Centrifugal

Maximum Temp: 175°F/80°C

Viscosity: 1500 Cps/mPas (280, ENC, 400)
750 Cps/mPas (A-2, ODP)
450 Cps/mPas (A-1)

Wetted Materials: Polypropylene
Carbon
Hastelloy

Discharge Options: 1" (25mm) barb
3/4" (22mm) barb

Maximum Specific Gravity: 1.8

Model	Tube Assembly	Length	Shaft	Impeller
SP-PHT-27	Polypropylene	27" (700 mm)	Hastelloy	High Volume
SP-PHT-39	Polypropylene	39" (1000 mm)	Hastelloy	High Volume
SP-PHT-47	Polypropylene	47" (1200 mm)	Hastelloy	High Volume
SP-PHT-60	Polypropylene	60" (1500 mm)	Hastelloy	High Volume
SP-PHT-72	Polypropylene	72" (1800 mm)	Hastelloy	High Volume
SP-PHT-HH-27	Polypropylene	27" (700 mm)	Hastelloy	High Pressure
SP-PHT-HH-39	Polypropylene	39" (1000 mm)	Hastelloy	High Pressure
SP-PHT-HH-47	Polypropylene	47" (1200 mm)	Hastelloy	High Pressure
SP-PHT-HH-60	Polypropylene	60" (1500mm)	Hastelloy	High Pressure
SP-PHT-HH-72	Polypropylene	72" (1800 mm)	Hastelloy	High Pressure

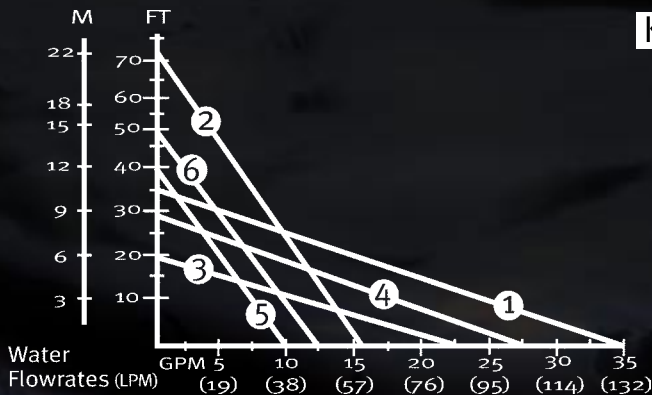
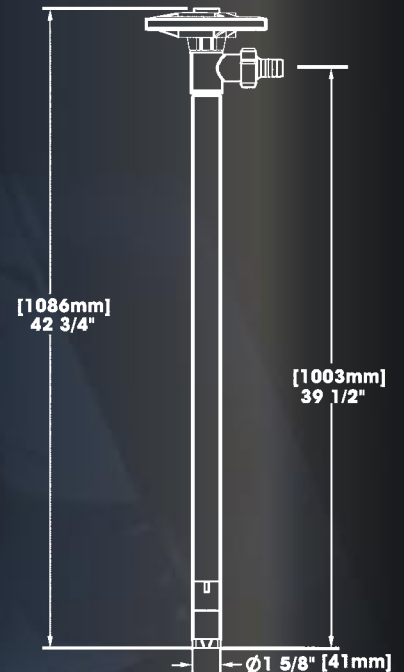

KEY:

- ① 280,ENC, 400/High Volume Tube
- ② 280,ENC, 400/High Pressure Tube
- ③ A-1/High Volume Tube
- ④ A-2, ODP/High Volume Tube
- ⑤ A-1/High Pressure Tube
- ⑥ A-2, ODP/High Pressure Tube

Warning: Not suitable for pumping flammable or combustible liquids

Pump Packages

PUMP PACKAGE 1

(Water Treatment Chemicals)

Engineered to transfer corrosive chemicals associated with the water treatment industry. Common applications include: Sodium Hypochlorite, Potassium Hydroxide and Sodium Bromide.

Motor type:	SP-280P or SP-280P-2
Pump assembly:	CPVC
Pump length:	39" (1000 mm)
PVC hose:	6 ft. (1.8 m), I.D. 1" (25 mm)
Dispensing nozzle:	1" (25 mm), polypropylene
Barrel adapter:	Polypropylene
Storage bracket:	16 gauge coated steel
Max flow rate:	35 GPM (132 LPM)
Max. pressure:	35 ft. (10 M)
Max. viscosity:	1500 CPS / Mpas
Max. temperature:	190°F (90°C)

PART NUMBER:

9430	110 Volt package
9431	230 Volt package

PUMP PACKAGE 2

(Acids & Alkalies)

Engineered to transfer mildly corrosive liquids. Common applications include: Hydrochloric Acid, Nitric Acid - 20%, Acetic Acid and Sulfuric Acid.

Motor type:	SP-280P or SP-280P-2
Pump assembly:	Polypropylene
Pump length:	39" (1000 mm)
PVC hose:	6 ft. (1.8 m), I.D. 1" (25 mm)
Dispensing nozzle:	1" (25 mm), polypropylene
Barrel adapter:	Polypropylene
Storage bracket:	16 gauge coated steel
Max flow rate:	35 GPM (132 LPM)
Max. pressure:	35 ft. (10 M)
Max. viscosity:	1500 CPS / Mpas
Max. temperature:	130°F (55°C)

PART NUMBER:

9400	110 Volt package
9401	230 Volt package

PUMP PACKAGE 3

(Concentrated Acids & Alkalies)

Engineered for transferring very concentrated and extremely aggressive liquids. Common applications include: Sulfuric Acid 66 Baumé, Propionic Acid, Concentrated Nitric - 98% and Hydrofluoric Acid.

Motor type:	SP-ENC or SP-ENC-2
Pump assembly:	PVDF
Pump length:	39" (1000 mm)
PVC hose:	6 ft. (1.8 m), I.D. 1" (25 mm)
Dispensing nozzle:	1" (25 mm), PVDF
Barrel adapter:	Polypropylene
Storage bracket:	16 gauge coated steel
Max flow rate:	35 GPM (132 LPM)
Max. pressure:	35 ft. (10 M)
Max. viscosity:	1500 CPS / Mpas
Max. temperature:	175°F (80°C)

PART NUMBER:

9420	110 Volt package
9421	230 Volt package

www.standardpump.com

Pump Packages *Continued*

PUMP PACKAGE 4

(Acids & Alkalies Measurement)

Unique design allows users to safely measure and transfer mildly corrosive liquids. Common applications include: Hydrochloric Acid, Nitric Acid - 20%, Acetic Acid and Sulfuric Acid.

Motor type:	SP-280P or SP-280P-2
Pump assembly:	Polypropylene
Pump length:	39" (1000 mm)
PVC hose:	6 ft. (1.8 m), I.D. 1" (25 mm)
Dispensing nozzle:	1" (25 mm), polypropylene
Flow meter:	Digital / polypropylene totalizer
Barrel adapter:	Polypropylene
Storage bracket:	16 gauge coated steel
Max flow rate:	35 GPM (132 LPM)
Max. pressure:	35 ft. (10 M)
Max. viscosity:	300 CPS / Mpas
Max. temperature:	130°F (55°C)

PART NUMBER:

9500	110 Volt package
9501	230 Volt package



PUMP PACKAGE 5

(Concentrated Acids & Alkalies Measurement)

Unique design allows operators to safely measure and transfer concentrated and very aggressive liquids. Common applications include: Sulfuric Acid 66 Baumé, Propionic Acid, Concentrated Nitric - 98 and Hydrofluoric Acid.

Motor type:	SP-ENC or SP-ENC-2
Pump assembly:	PVDF (Kynar®)
Pump length:	39" (1000 mm)
PVC hose:	6 ft. (1.8 m), I.D. 1" (25 mm)
Dispensing nozzle:	1" (25 mm), PVDF
Flow meter:	Digital / PVDF totalizer
Barrel adapter:	Polypropylene
Storage bracket:	16 gauge coated steel
Max flow rate:	35 GPM (132 LPM)
Max. pressure:	35 ft. (10 M)
Max. viscosity:	300 CPS / Mpas
Max. temperature:	175°F (80°C)

PART NUMBER:

9510	110 Volt package
9511	230 Volt package



Note: Special configurations are available upon request. Please consult factory.

Motor & Tube Assembly Detail

Variable speed control



Unique drop-in brush system

Multi certified motors meet stringent North American and European standards

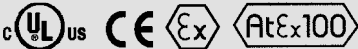

Powerful 1.1 hp (825 watt) Double insulated motors 115 / 220v models

Motor housing provides added chemical resistance

Optional thermal overload or low voltage release switches

Handwheel modular design

Optional 1" or 3/4" barbed fitting

Thick, robust wall construction

TFE guide sleeve finned design

Hastelloy C drive shaft

Carbon insert

Impeller/rotor interchangeable for high volume/high pressure models



ACCESSORIES

Nozzles

The chemically resistant dispensing nozzle offers a controlled solution for safe chemical transfer. Ideal for transferring aggressive liquids from large vessels to small containers. Available in polypropylene, PVDF, brass, and stainless steel. Discharge size 1" (25mm)



Wall Brackets

The wall mounting storage bracket is designed for pump storage while not in service. Constructed from 16 gauge, vinyl coated steel. The wall bracket offers a great solution in corrosive environments.



Barrel Adapters / Fume Barriers

Instrumental in vertically stabilizing your drum and container pump. Engineered for 2" (41mm) openings. Available materials include polypropylene and stainless steel.

Designed to reduce fume emission associated with concentrated chemicals and solvents. Available in polypropylene (Viton® Seal) and stainless steel (Viton® Seal).



Strainers

The pump tube strainer is designed to eliminate damage caused by particulates /contaminated liquids. Available in polypropylene and stainless steel.



Poly mesh: .78 x .078" (19.8 mm x 1.98 mm)

Stainless mesh: .78 x .078" (19.8 mm x 1.98 mm)

ACCESSORIES CONTINUED

Inline Flow Meter Kits for Drum Pumps

The Inline Flow Meter kits are designed for accurately measuring volume and flow rate. The kits come complete with a digital flow meter, quick action hand nozzle, and 1" (25mm) intake hose barb. Inline flow meter kits are available in: polypropylene, PVDF, and 316SS. Powered by a 9v /dc battery (battery included). No assembly required.



Locking Quick Disconnects

The quick locking cam levers are engineered to rapidly connect / disconnect hoses from pump discharge ports. Locking Quick Disconnects are available in chemically resistant polypropylene or rugged 316SS. Discharge connection is a 1" (25mm) hose barb fitting. The locking quick disconnects fit directly onto the threaded pump discharge port.



Transfer Hose

The clear PVC transfer hose is designed to handle a variety of corrosive chemicals, light petroleum products, etc. Available in 12" (.3m) increments this hose quickly adapts to all Standard Drum Pump discharge 1" (25mm) ports. Max. operating pressure: 30psi (2bar). The braided PVC hose is designed for applications requiring a rugged hose due to extreme environmental conditions or excessive discharge pressures. Available in 12" (.3m) increments this hose quickly adapts to all Standard Drum Pump discharge 1" (25mm) ports. Max. operating pressure: 130psi (8.9bar).



Grounding Wires

Standard Pump grounding wire sets are designed to properly ground pumps, motors, hose, and accessories while pumping flammable/ combustible liquids with a certified Explosion proof motor and 316SS pump tube. Ground wire set includes: 1 ft. (.3m), two 6ft. (2m), and a 10ft. (3m) section. All ground wire sets are equipped with Stainless clamps for secure connection. All 316SS pump tubes are equipped with a complete Ground Wire Set.



Worldwide Distribution



Argentina	Netherlands
Australia	New Zealand
Austria	Norway
Belgium	Peru
Brazil	Poland
Bulgaria	Portugal
Canada	Puerto Rico
Chile	Romania
China	Saudi Arabia
Czech Republic	Singapore
Denmark	Slovakia
Egypt	South Korea
Finland	South Africa
France	Spain
Greece	Sweden
Hong Kong	Switzerland
India	Taiwan
Indonesia	Thailand
Ireland	Turkey
Japan	U.A.E.
Korea	United Kingdom
Malaysia	United States
Mexico	Venezuela

BARREL AND CONTAINER PUMPS

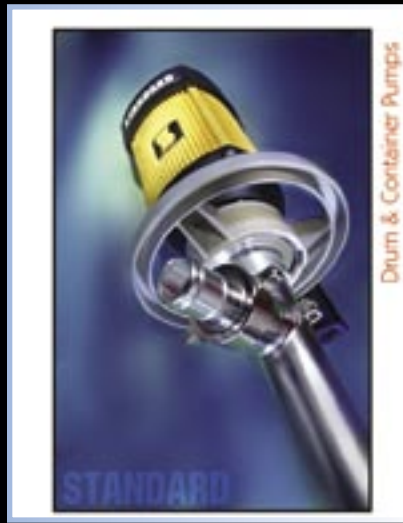

Drum & Container Pumps

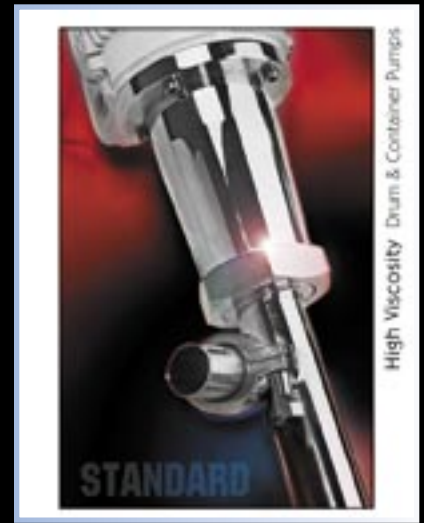

High Viscosity Drum & Container Pumps

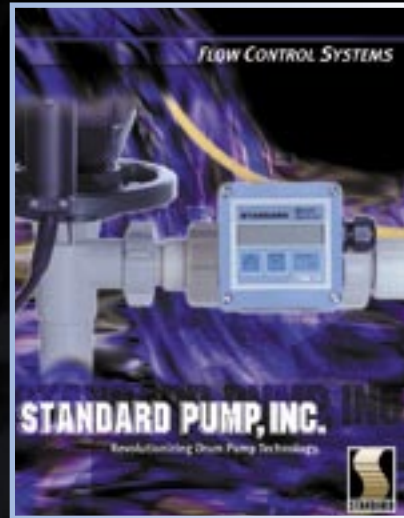

Flow Control Systems

STANDARD PUMP, INC.

3230 Industrial Way • Snellville, GA 30039

Toll Free: 800.428.2408

Tel: 770.972.9693

Fax: 770.972.9694

info@standardpump.com

www.standardpump.com

Distributed By:

