

SONIC-PRO[®]

Series S4



Ultrasonic Flow Meter
Installation and Operating Manual



ProSeries[®]
by Blue-White Ind.

Safety Precautions

Thank you for purchasing the **Sonic-Pro series S4** ultrasonic flowmeter.

This instruction manual provides important information regarding the safe installation, operation and maintenance of the flowmeter. Please read it carefully before attempting to install or operate the meter. A copy of this manual should be kept by the operator. Extra copies of this manual are available from your supplier or directly from the manufacturer.

The following important symbols are used throughout this manual and on labeling affixed to the flowmeter:

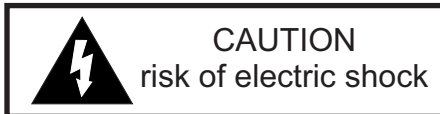

This symbol identifies a risk of electric shock where the possibility of injury or death is present.

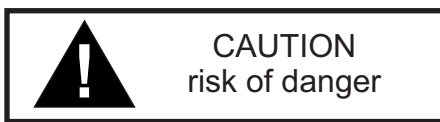

This symbol identifies a risk of injury or death is present.



In all cases, when this symbol is used on labeling affixed to the flowmeter, the documentation needs to be consulted to find out the nature of the potential HAZARD and any actions which have to be taken.

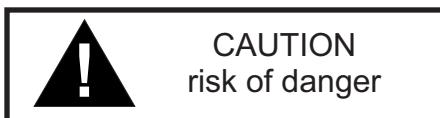

If the equipment is used in a manner not specified by this instruction manual, the protection provided by the equipment may be impaired.

QUESTIONS REGARDING THE SAFE USE OF THIS PRODUCT AND OTHER TECHNICAL ASSISTANCE MAY BE DIRECTED TO:

Blue-White Industries
714-893-8529
techsupport@blue-white.com

ProSeries™
by Blue-White Ind.

Made In USA
5300 Business Dr
Huntington Beach
CA 92649

Sonic-Pro
Ultrasonic Flowmeter
Model No.: S4X0CX
Serial No.: 07172013-0800
Voltage: 15~28VDC - 15W



ETL Listed
Conforms To UL STD 61010-1
Certified To
CAN/CSA STD C22.2 No. 61010-1



ENCLOSURE TYPE "NEMA" 4X
BOTTIER DE TYPE "NEMA" 4X



Acceptable For Indoor and Outdoor Use



CAUTION - To reduce risk of electric shock, disconnect electricity before removing back cover.



ATTENTION - Pour reduire le risque de la decharge electrique, l'electricite de debranchement avant d'enlever la couverture arriere.

Sonic-Pro
Ultrasonic Flowmeter



Certified to NSF / ANSI Standard 61

Drinking Water System
Components Health Effects

1.0 Product Overview

The Sonic-Pro series S4 Ultrasonic Flow Meter can measure fluid flow in water and many other clean fluids with sound speeds that are similar to water. The meter measures fluid flow using the Transit Time method. The S4 ultrasonic sound transducers do not touch the process fluid and there are no moving parts. This method of flow measurement is safe, non-intrusive and requires little to no maintenance.

The fluid being measured must be relatively “clean” to enable the sound waves to complete their circuit. The maximum amount of particles should not exceed 5% (50,000 ppm). The meter cannot measure through air. Air bubbles and excessive turbulence will disrupt the sound beam.

The angle of the sound beam, as it travels through a material, is effected by the speed that sound travels through that material. As the sound speed changes, the angle changes. Sound travels through 68°F clean water at a speed of 1,481 meters per sec. The S4 ultrasonic sound transducers are factory positioned for a fluid sound speed of 1,500 m/sec +/- 100. They cannot be adjusted in the field.

Water that contains concentrations of other chemicals, or other chemicals entirely, may be acceptable provided the chemical does not change the sound speed (SOS) more than approximately +/- 100 meters per second and provided the fluid allows the sound beam to pass through unimpeded. Note that the speed that sound travels through the fluid is effected by changes in the fluid’s density.

The S4 includes a 6-button user interface that can be used to configure the meter. The optimum sound speed setpoint can be adjusted by the user within the range of 1,500 m/sec +/- 100 m/sec.

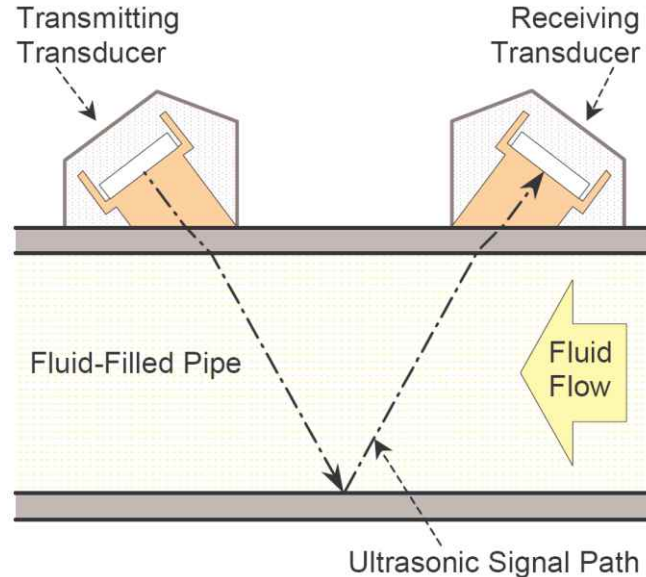

TRANSIT TIME MEASUREMENT PRINCIPLE

During operation in the Transit Time measurement method, a short ultrasonic signal burst passes first in one direction and then in the other between two transducers separated along the length of the pipe. When traveling in the same direction as fluid flow, the burst is carried along by the fluid and arrives earlier as a result. When traveling against fluid flow, the burst is held back by the fluid and arrives later. The SPU (Signal Processing Unit) measures this difference in time-of-flight in the two directions. From this, the actual time-of-flights, the distance traveled in the fluid and the angle of the ultrasonic signal path, it calculates the fluid velocity.

2.0 Flowmeter SPU Installation

2.1 Unpacking

The Sonic-Pro Flowmeter is shipped with the following items:

- Sonic-Pro Flowmeter SPU (Signal Processing Unit)
- Sonic-Pro Inline Pipe Fitting
- Enclosure Mounting Hardware (not included in sensor mounted units)
 - 2 mounting plates
 - 4 mounting plate screws (10-32 x .50")
 - 2 wall mounting screws (#10 x 1.00")
 - 1 pipe mounting clamp (maximum pipe diameter 10")
- Instruction Manual

The Sonic-Pro was designed to be installed and operated by qualified personnel only. Do not attempt to install or operate the meter if you are unsure. Seek qualified assistance. **Please note that warranty coverage does not include damage due to misuse or improper installation.**

2.2 Mounting Location

If remote mounting the SPU, select a mounting location that is within reach of the transducer cables and power supply. The transducer cable **must not be cut or modified**. Note that the Sonic-Pro can accurately measure flow from either direction.

The SPU can be mounted on a wall or on a horizontal or vertical run of pipe. Although the Sonic-Pro is designed to withstand outdoor conditions. A cool, dry location, where the unit can be easily monitored is recommended. Special ventilation is not required.

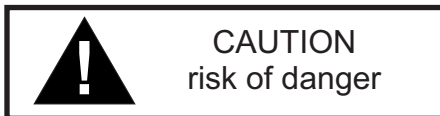

Do not position the equipment so that it is difficult to disconnect the power supply cord.

2.3 Wall or Pipe Mounting

When the SPU is not mounted directly to the **Inline Fitting**, the SPU must be installed on a **solid, secure surface** such as a **solid wall, panel, wall studs, etc.** DO NOT install the meter on drywall with anchor bolts.

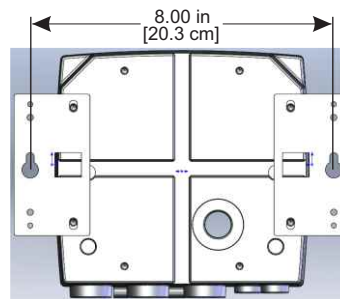

The SPU can be mounted on horizontal or vertical pipe. The pipe must be secure and of sufficient strength to support the weight of the SPU.

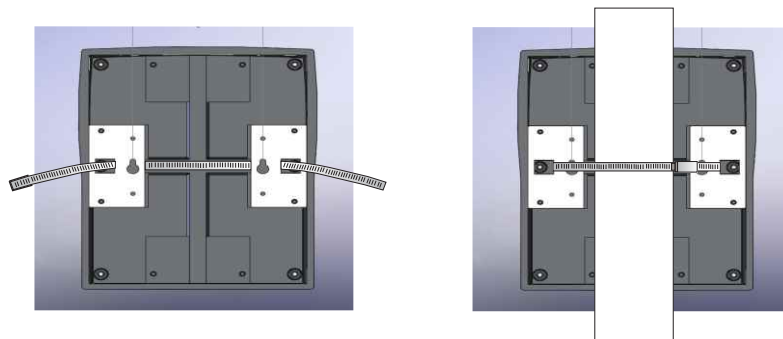

3.0 Ultrasonic Transducer Installation

3.1 Pipe Fitting/ Transducer Installation

Minimum Straight Pipe Length Requirements

The Sonic-Pro's sound wave beam is only affected by fluid that actually passes through the beam and therefore, the meter will not measure with high accuracy if the fluid velocity is not consistent across the entire pipe diameter. Flow disturbances such as pumps, elbows, tees, and valves in the flow stream can cause swirl patterns and vortices that will affect the measurement accuracy or disrupt flow measurement capability. Install the transducers on a straight run of pipe **as far as possible** from any disturbances. The distance required for high accuracy will depend on the type of disturbance.

Type of Disturbance	Straight Lengths of Pipe Required	
	Upstream from Transducers	Downstream from Transducers
Flange	5 x Nominal Pipe Size	5 x Nominal Pipe Size
Reducer	7 x Nominal Pipe Size	5 x Nominal Pipe Size
90° Elbow	10 x Nominal Pipe Size	5 x Nominal Pipe Size
Two 90° Elbows - 1 Direction	15 x Nominal Pipe Size	5 x Nominal Pipe Size
Two 90° Elbows - 2 Directions	20 x Nominal Pipe Size	5 x Nominal Pipe Size
Gate valve or Pump	25 x Nominal Pipe Size	5 x Nominal Pipe Size

Transducer Mounting Requirements

- The meter can be mounted on horizontal or vertical runs of pipe.
- Mounting anywhere around the diameter of vertical pipe is acceptable, however, the pipe must be completely full of fluid at all times.
- Back pressure is required on downward flows to ensure a full pipe.
- See the minimum straight length of pipe requirement chart above.
- Related piping must be independently supported. The meter should not be allowed to support the weight of related piping.

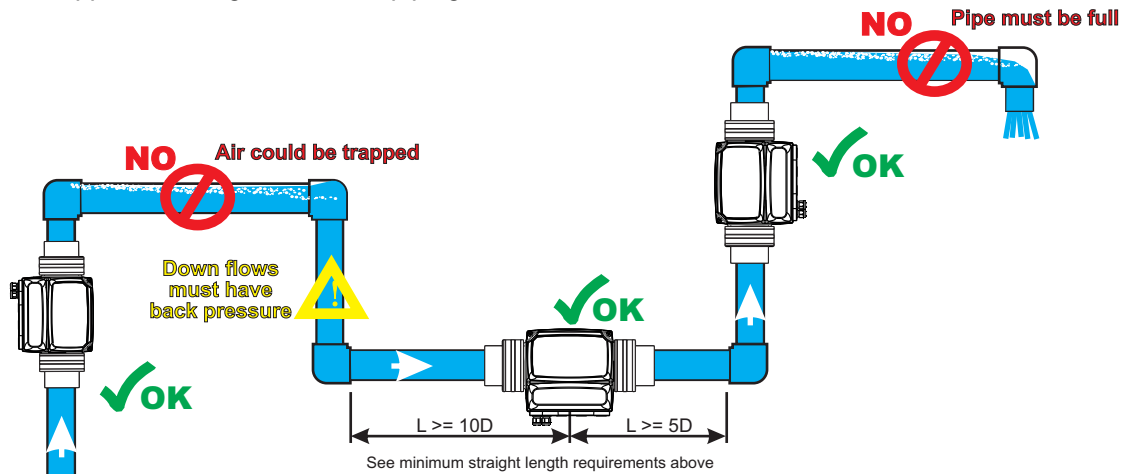

INLINE PIPE FITTING
TEMPERATURE VS PRESSURE

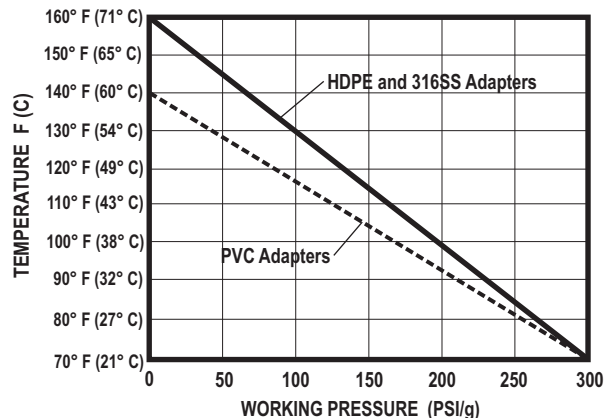

4.0 Wiring Installation

4.1 Electrical Connections

The meter must be powered by 15 to 28 volts DC. Depending on the model ordered, an AC/DC plug-in transformer may have been supplied for this purpose. See the diagram below for wiring of output signals, communications signals and process control relays.

The transducer cable length is factory fixed. **Do not attempt to modify the length of these cables.** Various cable lengths are available from the factory. Contact the factory if you need assistance.

Shielded cable is recommended for signal output connections.

4.2 Cable Gland Liquid-Tight Connections

The Sonic-Pro SPU wiring compartment is equipped with:

- Three liquid-tight cable gland connectors for cable diameter from .200 to .394 inches (5.1 to 10.0 mm).
- Two liquid-tight cable gland connectors cable for diameters from .118 to .255 inches (3.0 to 6.5 mm).
- One communications cable liquid-tight cable gland grommet for cable diameters from .190 to .205 inches. It is provided for any one of the following cable types:

Ethernet Cable
RS-232 serial cable

Note that the blank grommet plug should be used when the communications cable grommet is not required.

4.3 Wiring Compartment

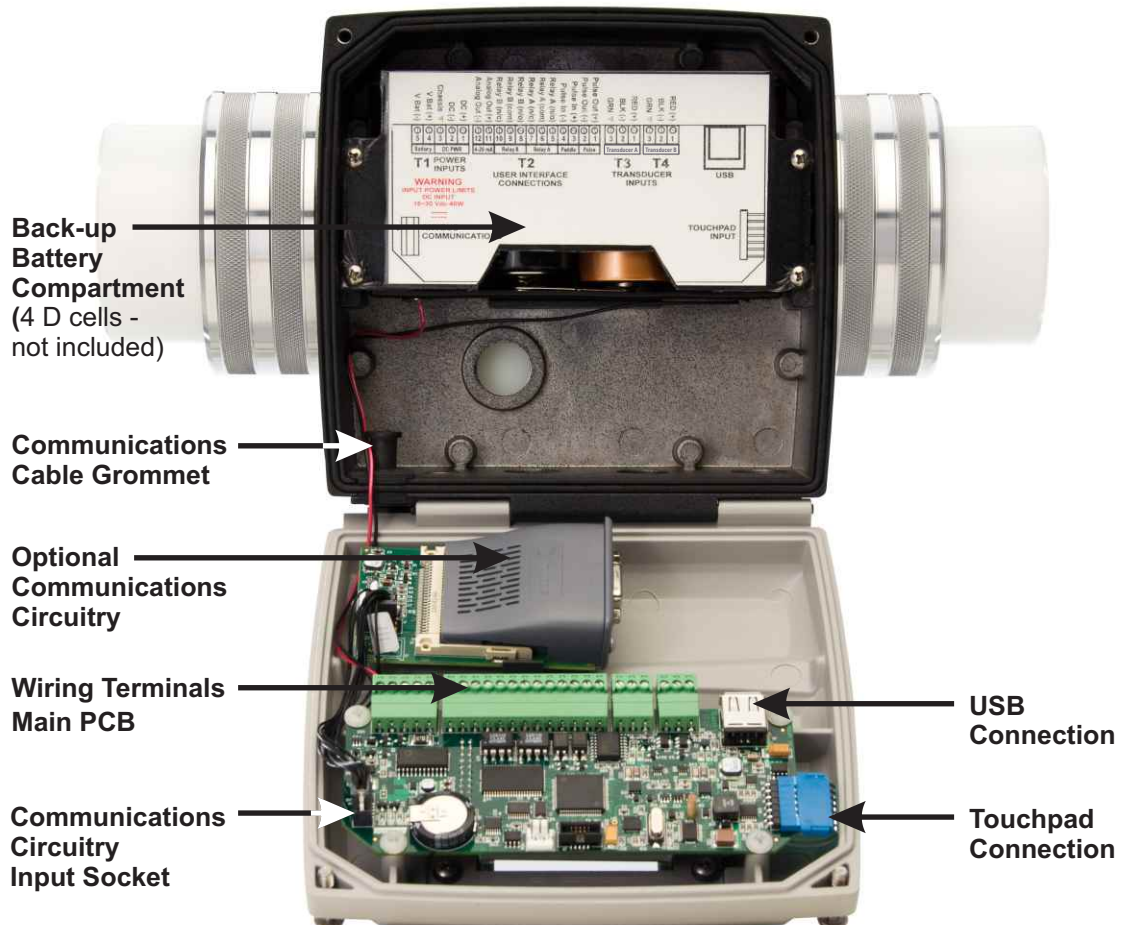

4.4 Wiring Terminals

The terminal blocks are plug type capable of accepting 14 to 30 AWG wire.

FUNCTION	TERM	PIN #	RATING	DESCRIPTION
POWER INPUT: Primary power -----	T1	1	(+) 15-28 Vdc	15-28Vdc, 400mA max
		2	(-) 15-28 Vdc	
Chassis Ground	T1	3	Ground	
POWER INPUT: Battery Back-up power -----	T1	4	(+) Positive	4 D cell size batteries (Alkaline batteries only are acceptable)
		5	(-) Negative	
PULSE FREQUENCY OUTPUT: Open Collector	T2	1	(+) Positive	Type: Open collector w/ internal 1 K pull-up to 5V. Can be pulled up to 30V @ 10mA (3K pull-up) Duty Cycle: 50%+/-5% Frequency Range: 0-1000 Hz Resolution: 1 Hz Accuracy: 0.5% F.S.
		2	(-) Negative	
PADDLEWHEEL SENSOR INPUT: AC Sine wave	T2	3	(+) Positive	Blue-White model FC sensor. 100mVp-p, 10 to 350Hz
		4	(-) Negative	
RELAY 'A' OUTPUT	T2	5	Normally Open	Type: FORM C Load capacity: 30V, 100mA max (ext. supplied)
		6	Common	
		7	Normally Closed	
RELAY 'B' OUTPUT	T2	8	Normally Open	Type: FORM C Load capacity: 30V, 100mA max (ext. supplied)
		9	Common	
		10	Normally Closed	
Chassis Ground	T2	11	Ground	
ANALOG OUTPUT: 4-20 mA	T2	12	(+) Positive	Current output: 4-20 mADC, isolated. Max Load Impedance: 1K ohm Power: Internal Resolution: 12 bits Accuracy: Less than 0.1% F.S. Update Rate: 1.0 s
		13	(-) Negative	
TRANSDUCER INPUT: Transducer A	T3	1	(+) Red	
		2	(-) Black	
		3	Green or Bare	
TRANSDUCER INPUT: Transducer B	T4	1	(+) Red	
		2	(-) Black	
		3	Green or Bare	

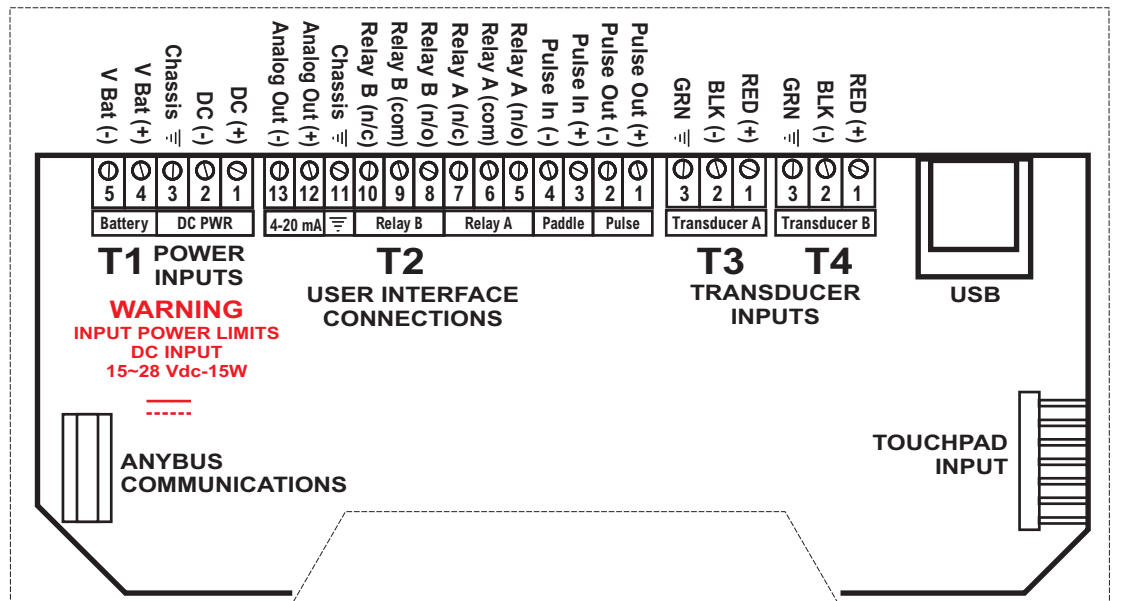

5.0 Operation

5.1 Power On

1. If power is present on Terminal T1 pins 1 & 2, the meter is always powered on.
2. If power is removed from Terminal T1 pins 1 & 2, and 4 D-Cell batteries are installed on Terminal T1 pins 4 & 5, the meter will stay on (battery back-up). Under these conditions, the meter can be turned on/off by pressing and holding the front panel ENTER button for three seconds.
3. If power is **only** present on the battery Terminal T1 pins 4 & 5, then the meter can be turned on/off by pressing and holding the front panel ENTER button for three seconds. Operating time is limited when powered by batteries only.

5.1.1 Battery Powered operation

While the batteries pack is provided primarily as back-up power, the S4 meter can be operated solely with 4 D-cell batteries (not included). The meter can be configured to sleep between measurements in order to conserve power. The approximate battery life is

Continuous Running	On / Sleep Time (seconds)			
	10 / 10	10 / 100	5 / 100	3 / 268
72 Hr	128 Hr	310 Hr	377 Hr	450 Hr

The following meter features are disabled during battery operation:

- Communications Module
- Analog output
- Pulse Frequency Output

5.2 Run Screen

When the S4 is factory ordered with a pipe fitting/transducer, the pipe fitting data and the default display feature parameters are pre-configured. When power is applied and there is water in the pipe fitting, the following RUN display screen will be displayed.

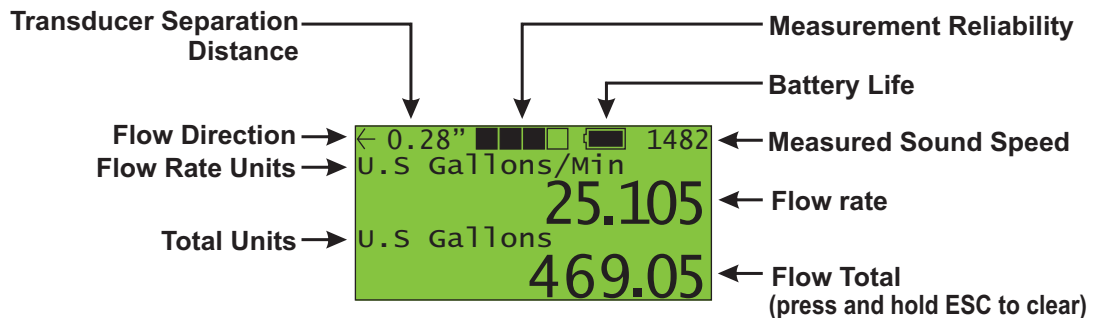

- Press the **ENTER** button to enter the menu system.
- Press the **ESC** button to clear the flow total to zero (if enabled in configuration).
- Press the up arrow **▲** to toggle the flow rate to linear Feet/Sec., Meters/sec and back to the configured user units of measure.

5.2.1 Fault Screen

There are three possible FAULT indicator screens.

- **FAULT 11** - Transducers are not connected or there is no fluid in the pipe.
- **FAULT 12** - The allowable SOS (Speed Of Sound) error set-point has been exceeded.
- **FAULT 21** - The configuration data is not valid.

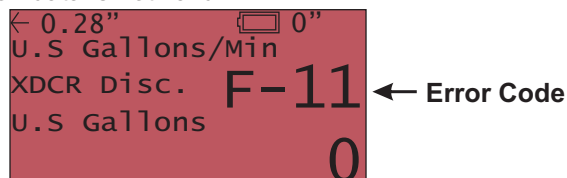

5.3 Menu Navigation

The Configuration Menu

From the RUN mode, press and release the **ENTER** button to enter the CONFIGURATION menu. The following menu will be displayed:

5.3.1 Selecting and Entering Menus

- Press up arrow ▲ or down arrow ▼ to select menu items. The selected item will be highlighted.
- Press right arrow ► or **ENTER** to enter the selected menu.
- Press left arrow ◀ to go back one menu.
- Notice the gray area. These menu items are hidden from view. Press the up arrow ▲ or down arrow ▼ to display hidden menu items.

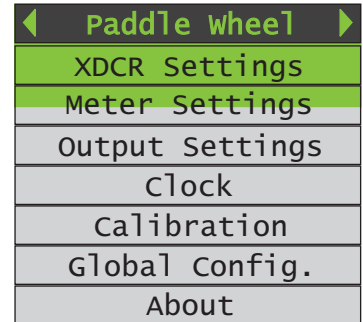

5.3.2 Selecting Optional Items

- Press up arrow ▲ or down arrow ▼ to select optional configuration items. The selected item will be highlighted.
- Press left arrow ◀ or **ENTER** to choose the selected optional item and return to the menu heading.

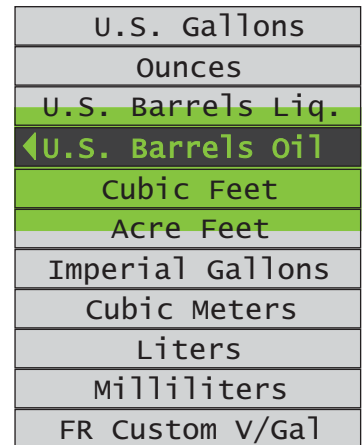

5.3.3 Inputting Data

- Press right arrow ► or left arrow ◀ to select a digit to modify. Pressing the left arrow ◀ will create additional numbers to the left.
- Press up arrow ▲ to increase or down arrow ▼ to decrease the value.
- Press **ENTER** to confirm the modifications and return to the menu heading.
- Press **ESC** to cancel the modifications and return to the menu heading.

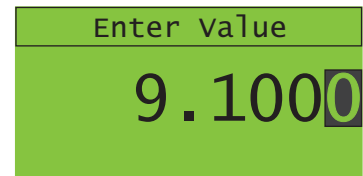

5.3.4 Save Configuration

- Press left arrow ◀ to exit to the main menu.
- Press down arrow ▼ to Highlight **Save Config.**
- Press right arrow ► or **ENTER** to save the configuration changes.
- Press **ENTER** to confirm the configuration changes have been saved.
- Press up arrow ▲ to RUN.
- Press right arrow ► or **ENTER** to enter the RUN mode,

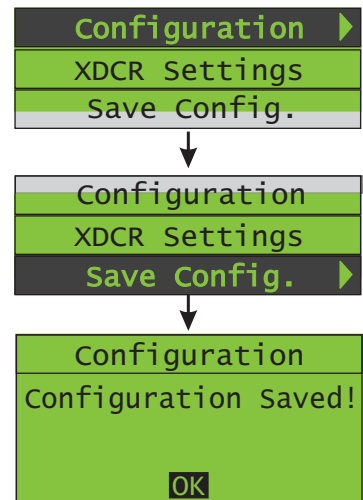

6.0 Configuration

The S4's SPU can be used with a Paddle Wheel type sensor that outputs an AC Sine wave or an Ultrasonic type sensor.

6.1 Configure the SPU for a Paddle Wheel Sensor

When using an AC Sine wave **Paddle Wheel** type flow sensor and pipe fitting, the installer must input the pipe fitting K-factor. The K-Factor is the total number of pulses output by the sensor per gallon of fluid flow for a specific pipe fitting. The K-factor is different for each pipe fitting. See the paddle wheel sensor's instruction manual for a list of pipe fitting K-factors.

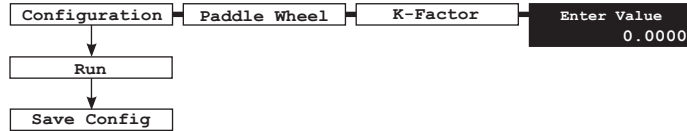

6.2 Configure the SPU for an Ultrasonic Inline Pipe Fitting

When using Ultrasonic Transducers (**XDCR**), if the SPU and the **Ultrasonic Inline Pipe Fitting** was shipped from the factory as a single model number, the SPU is pre-configured with the proper model number and calibration constants shown on the calibration label attached to the pipe fitting. **If the pipe fitting was sold separately, the SPU will need to be configured with the following data shown on the calibration label:**

1. **Measurement Units.** The default value for all inline fittings is ENGLISH.
2. **Model.** The default value for all inline fittings is "C".
3. **Mount Method.** The default value for all inline fittings is "V".
4. **Cable Length.** Enter the length in feet. The available cable lengths are: 1 foot (SPU mounted directly on the pipe fitting), 10, 25, 50 or 100 feet.
5. **Flow Direction -> Direction.** The default value for all inline fittings is "A -> B".
6. **Flow Direction -> Settings.** Each flow direction has a unique SCALING and ZERO VALUE number shown on the pipe fitting calibration label. Note that the ZERO number may be POSITIVE or NEGATIVE.
7. **Pipe Outside Diameter.** Shown on the pipe fitting calibration label. Do not use your inlet/outlet pipe size.
8. **Pipe Wall Thickness.** Shown on the pipe fitting calibration label. Do not use your nominal pipe size.
9. **Pipe Material.** Shown on the pipe fitting calibration label. Do not use your inlet/outlet pipe material.
10. **Fluid Type.** Select WATER or CUSTOM.
11. **Fluid SOS.** If WATER is selected, it is not necessary to input a fluid SOS. If "CUSTOM" fluid type is selected, the Speed of Sound (SOS) for the custom fluid must be entered manually. Note that the SOS must be within the pipe fitting's SOS range.

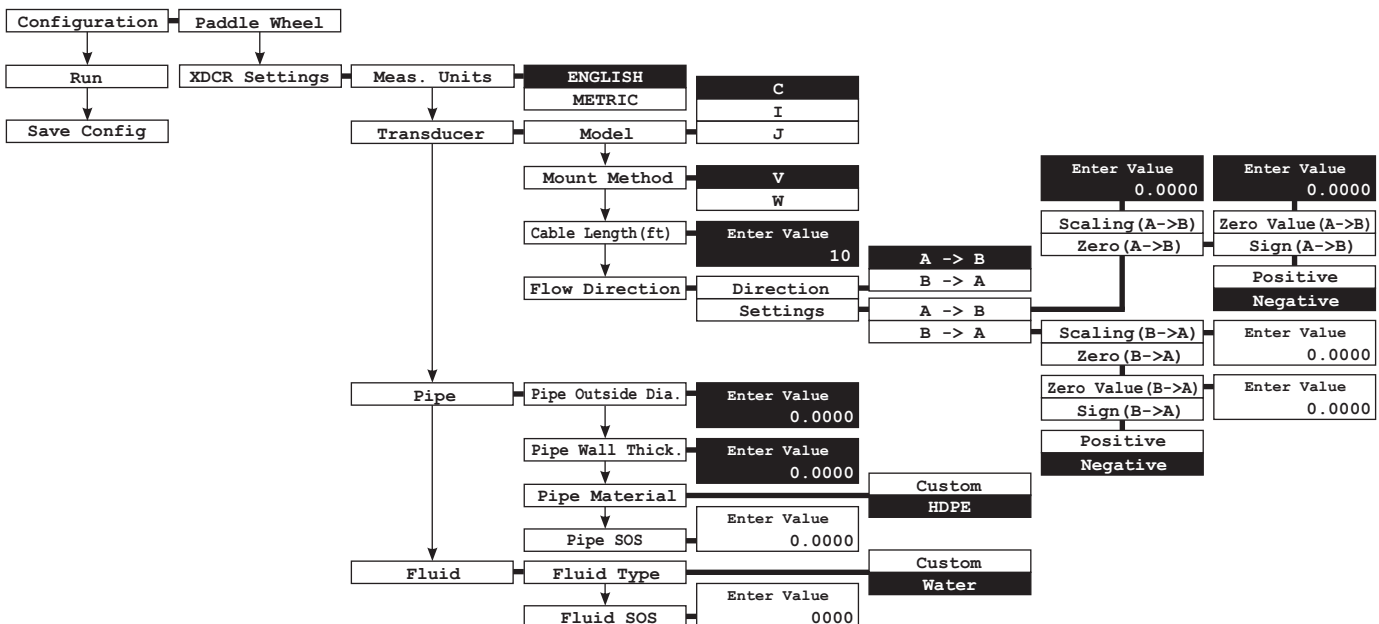

6.2.1 Measurement Units Menu

Select **ENGLISH** when entering the Pipe Outside Diameter and Pipe Wall Thickness dimensional data in Inches. Select **METRIC** when entering pipe the Outside Diameter and Pipe Wall Thickness dimensional data in millimeters.

Note that the factory default units is INCHES. These dimensions are shown on the **Calibration Detail** label affixed to the pipe fitting:

Meas. Units	ENGLISH
	METRIC

A→B SCALING: 0.975 ZERO: 0.455 ZERO +/- : NEG.	A←B SCALING: 0.975 ZERO: 0.455 ZERO +/- : NEG.
MEASUREMENT UNITS: ENGLISH MOUNT METHOD: V PIPE OUTSIDE DIAMETER: 2.375"	PIPE WALL: 0.218" PIPE MATERIAL: HDPE FLUID TYPE: WATER

CALIBRATION DETAIL LABEL

6.2.2 Transducer Menu

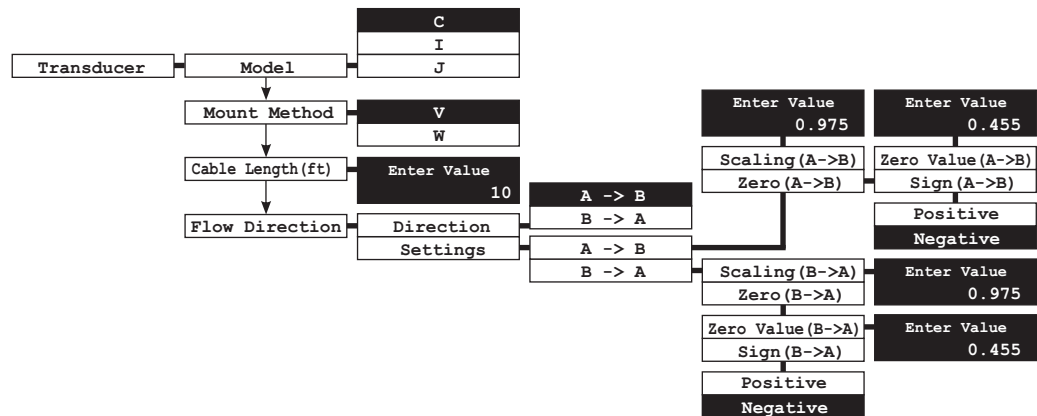

6.2.2.1 Transducer Model

There are three transducer **MODELS** available to select. When using the S4 Inline Pipe Fitting/Transducer, select model **C**. See the model number ordering matrix for additional transducer model options.

Transducer	Model	C
		I
		J

6.2.2.2 Transducer Mount Method

The transducers are factory set inside the pipe fitting and cannot be moved. Select the mount method that is shown on the **Calibration Detail** label affixed to the pipe fitting.

Transducer	Model	
	Mount Method	V
		W

6.2.2.3 Transducer Cable Length

Enter the transducer cable length. The available length options are:

- 1 = Sensor Mounted Display (no cable)
- 10 = 10 ft cable, transducer cable model number option "A"
- 25 = 25 ft cable, transducer cable model number option "B"
- 50 = 50 ft cable, transducer cable model number option "C"
- 100 = 100 ft cable, transducer cable model number option "D"

Transducer	Model	
	Mount Method	
	Cable Length(ft)	Enter Value 10

6.2.2.4 Fluid Flow Direction

The relative flow direction is shown on the **Calibration Detail** label affixed to the pipe fitting.

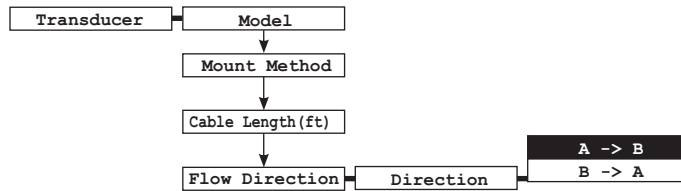

6.2.2.5 Fluid Flow Direction (CAL Settings)

Each of the flow directions (A to B and B to A) have a **Scaling Factor** and either a positive or negative **Zero Factor** associated with it. The correct factors are shown on the **Calibration Detail** label affixed to the ultrasonic flow sensor pipe fitting.

These are factory calibration factors that should not be changed without first contacting the factory for technical assistance.

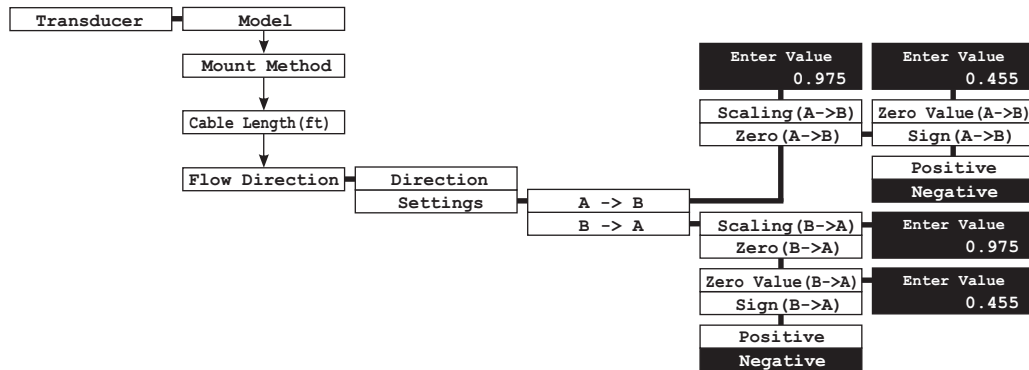

A→B SCALING: 0.975 ZERO: 0.455 ZERO +/- : NEG.	A←B SCALING: 0.975 ZERO: 0.455 ZERO +/- : NEG.
MEASUREMENT UNITS: ENGLISH MOUNT METHOD: V PIPE OUTSIDE DIAMETER: 2.375"	PIPE WALL: 0.218" PIPE MATERIAL: HDPE FLUID TYPE: WATER

CALIBRATION DETAIL LABEL

6.2.3 Pipe Menu

Each pipe fitting has a specific **Pipe Outside Dia.**, **Pipe Wall Thick.**, **Pipe Material** and **Pipe SOS** (Speed Of Sound) associated with it. The correct factors are shown on the **Calibration Detail** label affixed to the ultrasonic flow sensor pipe fitting.

These are factory calibration factors that should not be changed without first contacting the factory for technical assistance.

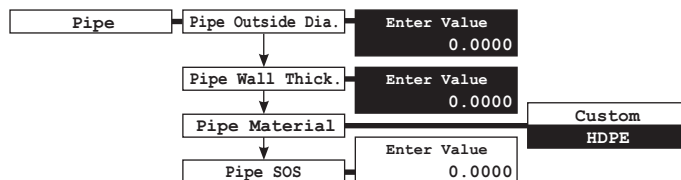

6.2.4 Fluid Menu

The sound transducers are located in the S4 pipe fitting. They are carefully positioned at the factory for use with water at 68 degrees F which has a SOS (Speed Of Sound) of 1481 meters per second. (see page 28 for water SOS chart). The transducer placement cannot be adjusted in the field. As the fluid's sound speed moves away from the target **Fluid SOS**, measurements become more difficult. If the speed that sound travels through the fluid is very different than that of water, the meter will not function. The acceptable SOS range is from 1,400 to 1,600 m/sec.

The meter will display the SOS of the fluid being measured in the upper right hand corner of the display.

Successful measurements are possible with fluids other than water provided the fluid's SOS is within the acceptable range and there are not too many particles or other sound blocking or reflecting contaminants in the fluid which can inhibit the sound beam.

The target **Fluid SOS** value can be adjusted to maximize the meter's ability to measure the fluid. The chart below provides the sound speeds of a number of chemicals of specific concentrations at specific temperatures. Diluted chemicals will have a different sound speed. Select **Custom** from the **Fluid Type** menu, then input the SOS fluid in the **Fluid SOS** menu.

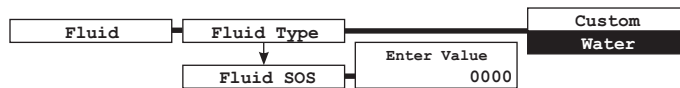

Fluid Sound Speeds

Fluid	Sound Speed (meters/sec)	Temp. °F (°C)
Water	1403	32 (0)
Water	1481	68 (20)
Water	1543	212 (100)
Sea Water	1520	68 (20)
Aluminum Sulfate 10% (Alum)	1900	68 (20)
Ethylene Glycol (50% in water)	1578	77 (25)
Gasoline	1250	77 (25)
Hydrochloric Acid 32%	1581	68 (20)
Hydrogen Peroxide 31%	1530	68 (20)
Milk	1548	77 (25)
Oil, Diesel	1250	77 (25)
Oil, Motor (SAE 30)	1487	68 (20)
Oil, Mineral	1431	77 (25)
Potassium Hydroxide 50%	2800	68 (20)
Sodium Hypochlorite 12%	1835	68 (20)
Sulfuric Acid 96%	1260	68 (20)

6.3 Configure the SPU Meter Settings

In the **Meter Settings** menu, the data logging functions and the display features can be configured.

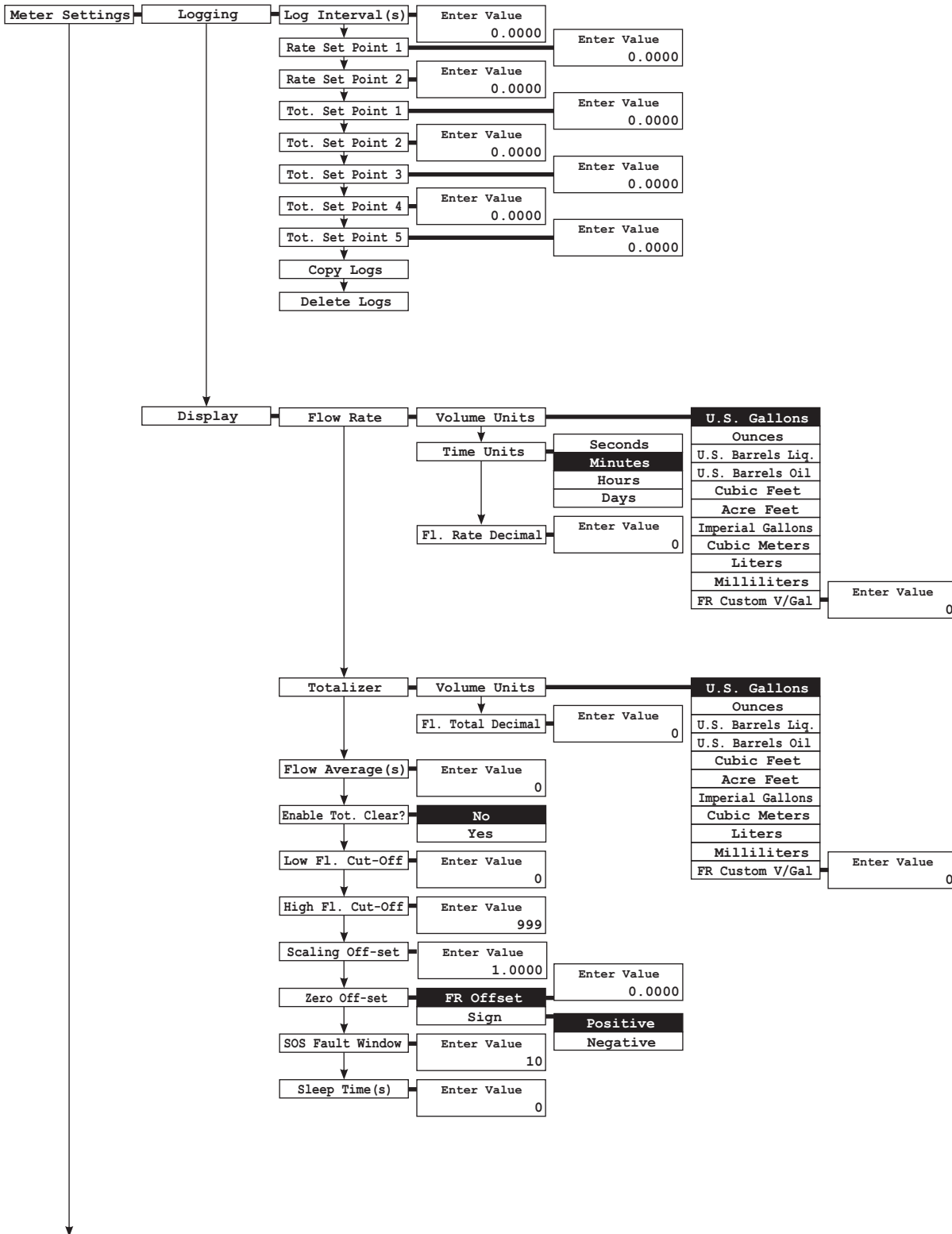

6.3.1 Logging Menu

Data logs are stored in the meter's internal memory in a space delimited .TXT file that can easily be copied to a removable USB flash drive located on the main circuit board. Each log file includes the date and time, the flow rate (FR) and the flow total (TL). A total of 191,800 logs can be stored.

2013/12/29 09:15:00 FR 0.0000 TL 0.00

The **Log Interval** determines the number of seconds from 1 - 999,999 that the meter will wait between logs.

If a value is entered into **Rate Set Point 1**, a new log will be generated every 60 seconds while the measured rate of flow is greater than the configured value.

If a value is entered into **Rate Set Point 2**, a new log will be generated every 60 seconds while the measured rate of flow is less than the configured value.

If a value is entered into any **Tot. Set Point (1, 2, 3, 4 or 5)**, a new log will be generated when the total accumulated flow value is equal to the configured value.

To access the log entries, you must copy the logs onto a USB flash drive and transfer the file to a computer for reading. To copy all of the log entries, open the enclosure and insert a USB flash drive. Highlight **Copy Logs** press either right arrow ► or **ENTER**. When copying logs, all of the logs must be copied. You may not copy only selected logs.

To delete ALL of the log entries, highlight **Delete Logs** then press either right arrow ► or **ENTER**. You may not delete only selected logs. All logs must be deleted.

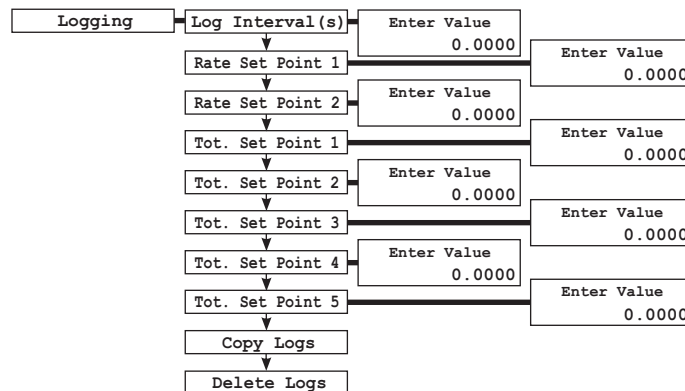

6.3.2 Display Menu

In the **DISPLAY** menu, the following features may be configured:

- Flow Rate - Volume Units
- Flow Rate - Time Units
- Flow Rate - Decimal Point Location
- Totalizer - Volume Units
- Totalizer - Decimal Point Location
- Flow Rate Averaging
- Enable/Disable clearing the totalizer from the front panel
- Low Flow Rate Cut-Off
- High Flow Rate Cut-Off
- Scaling Offset
- Zero Offset
- SOS Fault Window
- Sleep Time

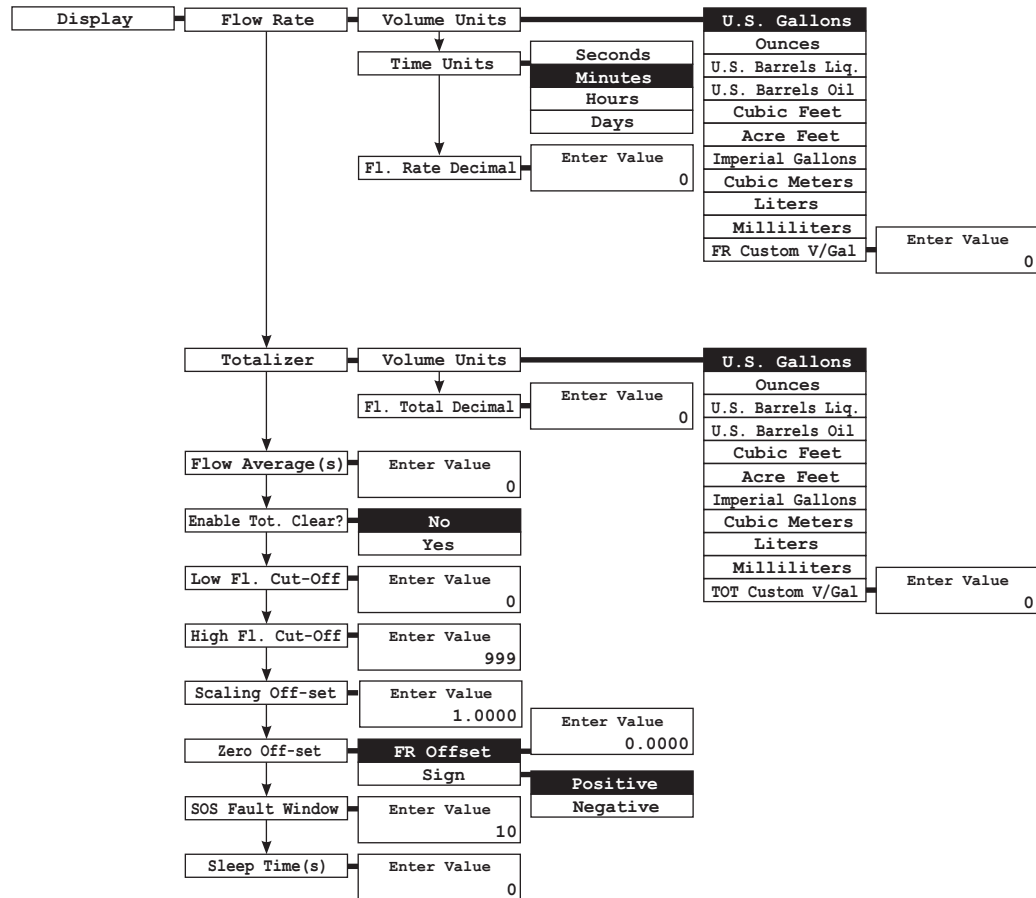

6.3.2.1 Flow Rate Menu

In the **Flow Rate** menu, the **Volume Units** and **Time Units** may be selected from a list.

A custom volume unit may be created by selecting **FR Custom V/Gal** and entering the number of gallons in the custom volume.

The **Fl. Rate Decimal** decimal point location may be set to a maximum of 5 digits.

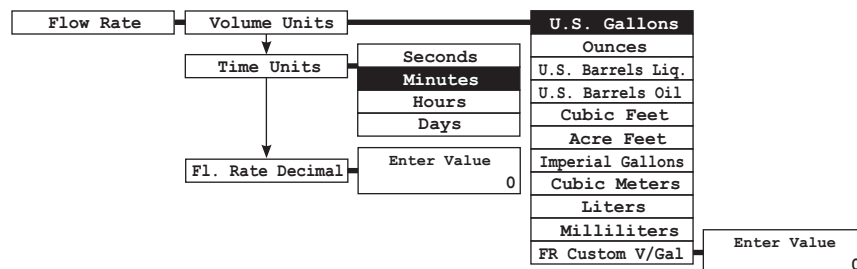

6.3.2.2
Totalizer Menu

In the **Totalizer** menu, the **Volume Units** may be selected from a list.

A custom volume unit may be created by selecting **FR Custom V/Gal** and entering the number of gallons in the custom volume.

The **FI. Total Decimal** decimal point location may be set to a maximum of 5 digits.

The screenshot shows the 'Totalizer' menu with 'Volume Units' selected. A dropdown list is open, showing options: U.S. Gallons, Ounces, U.S. Barrels Lig., U.S. Barrels Oil, Cubic Feet, Acre Feet, Imperial Gallons, Cubic Meters, Liters, Milliliters, and TOT Custom V/Gal. The 'U.S. Gallons' option is highlighted. Below the list, there is an 'Enter Value' field with '0' entered. To the left, the 'Fl. Total Decimal' field is also visible with '0' entered.

6.3.2.3
Flow Average Setting

Flow Average(s) sets the running average period in seconds. Any number of seconds from 2 to 10 seconds is possible.

The screenshot shows the 'Flow Average(s)' field with an 'Enter Value' box containing the number '0'.

6.3.2.4
Clear Total Setting

Enable Tot. Clear? enables or disables the ability of the user to clear the accumulated total flow by pressing the ESC button.

The screenshot shows the 'Enable Tot. Clear?' field with a selection menu. The 'No' option is currently selected and highlighted in black.

6.3.2.5
Low Flow Rate Cut-off Setting

Low FI. Cut-Off sets the minimum displayed flow rate. Calculated flow rate values less than this value will be displayed as Zero and flow totalizing will not occur.

The screenshot shows the 'Low FI. Cut-Off' field with an 'Enter Value' box containing the number '0'.

6.3.2.6
High Flow Rate Cut-off Setting

High FI. Cut-Off sets the maximum displayed flow rate. Calculated flow rate values greater than this value will be displayed as the **High FI. Cut-Off value**, totalizing will still occur.

The screenshot shows the 'High FI. Cut-Off' field with an 'Enter Value' box containing the number '999'.

6.3.2.7
Scaling Off-Set Setting

Scaling Off-Set is a multiplier used to correct for flow inaccuracies. All flow rate values will be multiplied by the **Scaling Off-Set** value and the result displayed and totaled.

The screenshot shows the 'Scaling Off-set' field with an 'Enter Value' box containing the number '1.0000'.

6.3.2.8
Zero Off-Set Setting

Zero Off-Set is a factory calibration value used to offset the zero flow setpoint during the initial calibration of the **Ultrasonic Inline Pipe Fitting**. The calibration value and sign should match the **ZERO: nnnn** value and **ZERO: +/- : xxx** value shown on the **Calibration Detail** label affixed to the pipe fitting.

These are factory calibration factors that should not be changed without first contacting the factory for technical assistance.

The screenshot shows the 'Zero Off-set' field with a selection menu. The 'FR Offset' option is selected and highlighted in black. Below it, there is an 'Enter Value' box with '0.0000' and a 'Sign' selection menu with 'Positive' selected.

A→B SCALING: 0.975 ZERO: 0.455 ZERO +/- : NEG.	A←B SCALING: 0.975 ZERO: 0.455 ZERO +/- : NEG.
<small>MEASUREMENT UNITS: ENGLISH PIPE WALL: 0.218" MOUNT METHOD: V PIPE MATERIAL: HOPE PIPE OUTSIDE DIAMETER: 2.375" FLUID TYPE: WATER</small>	

CALIBRATION DETAIL LABEL

6.3.2.8
SOS
(Speed Of Sound)
Fault Window

The S4 will monitor the sound speed (SOS) of the measured fluid and report FAULT 12 if the measured SOS exceeds the **SOS Fault Window** percentage value. The speed that sound travels through the fluid will change if the density of the fluid changes (temperature change) or if the fluid composition changes (chemical concentration, different chemicals, etc.). The default value is 10%. The maximum allowable value is 50%.

The screenshot shows the 'SOS Fault Window' field with an 'Enter Value' box containing the number '10'.

6.3.2.9 Sleep Timer

To conserve power, the S4 can be configured to “sleep” from 3 to 268 seconds per cycle. At the end of each sleep cycle, the meter will “wake” for the number of seconds (from 2 to 10 seconds) as configured in the **Flow Average** feature, record data, and then return to sleep. During the “wake” period, the display will remain blank.

The Flow Totalizer will estimate the amount of total fluid flow that would have been measured while the meter was sleeping, using the following formula:

$$\text{Total flow display value} = T1 + (F1 + F2 / 2) \times (N + 1)$$

Where:

T1 = Last total before sleep

F1 = Last flow rate (units per second) before sleep

F2 = Flow rate average of the 1st second of wake-up (units per second)

N = Seconds of sleep (Sleep Timer Value)

note: the one second is added to the Sleep Time for accusation time at wake.

The sleep cycle can be interrupted by pressing the ENTER button.

Data logging cannot occur while sleeping. Logging will occur if the meter is “awake” and if it is time to log data.

Sleep Time (s)	Enter Value
	0

6.4 Configure the SPU Output Settings

In the **Output Settings** menu, the **Analog 4-20mA**, **Pulse 0-1000 Hz**, **Contact Closures** and the **Anybus** Communications module functions can be configured.

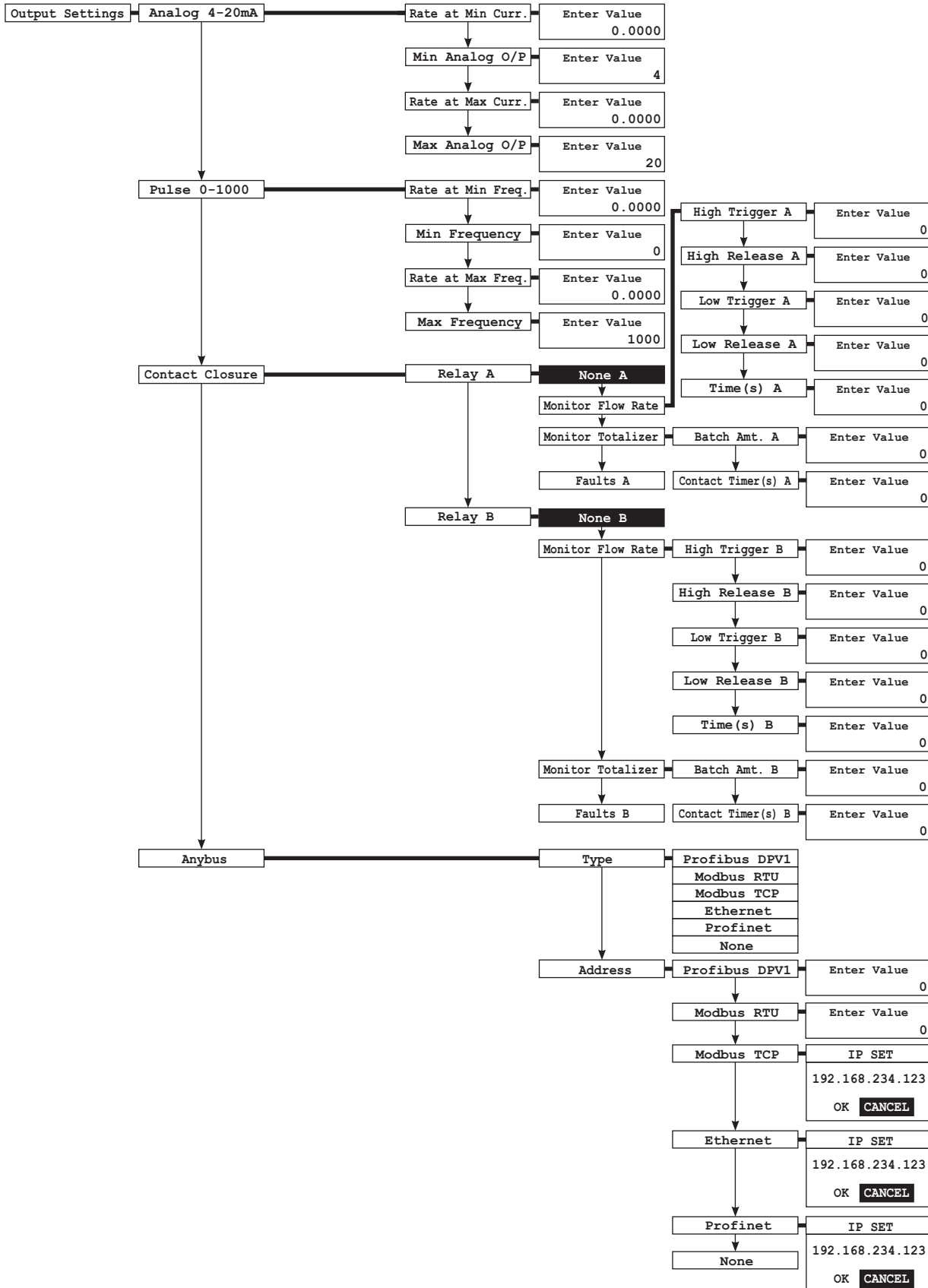

6.4.1 Analog 4-20mA Output Menu

An analog current output signal can be programmed within the range of 4-20mA.

Specify the flow rate at a minimum current (**Rate at Min Curr.**) and the corresponding minimum analog current (**Min Analog O/P**).

Specify the flow rate at a maximum current (**Rate at Max Curr.**) and the corresponding maximum analog current (**Max Analog O/P**).

The flow rates must not be the same. The current for the high flow rate may be smaller than the current for the low flow rate in which case, the current will decrease with increasing flow rate.

Flow rates are mapped to currents using a straight line through the two points specified.

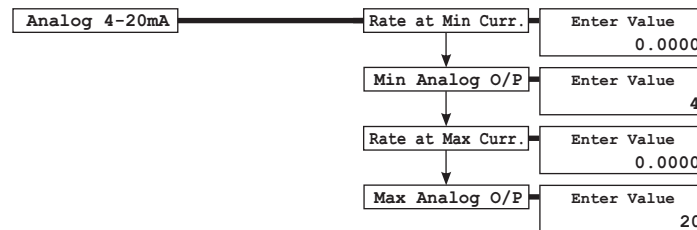

6.4.2 Pulse 0-1000 Hz Output Menu

A digital pulse output signal can be programmed within the range of 0-1000 Hz (pulses per second).

Specify the flow rate at a minimum frequency (**Rate at Min Freq.**) and the corresponding minimum frequency (**Min Frequency**).

Specify the flow rate at a maximum frequency (**Rate at Max Freq.**) and the corresponding maximum frequency (**Max Frequency**).

The flow rates must not be the same. The frequency for the high flow rate may be smaller than the frequency for the low flow rate in which case, the frequency will decrease with increasing flow rate.

Flow rates are mapped to frequencies using a straight line through the two points specified.

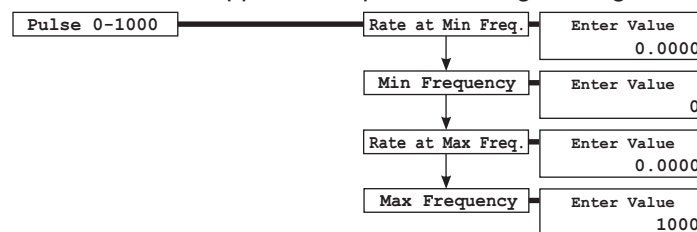

6.4.3 Contact Closure Relay Output Menu

The S4 has two Form C relays. Each can be independently configured to energize when one of the following conditions are met:

- A specific **Flow Rate** value is displayed, used for high, low or high/low range alarms.
- An **Accumulated Total** value has been measured. Used for triggering external equipment when a configured batch amount is reached.
- A **FAULT** has occurred.

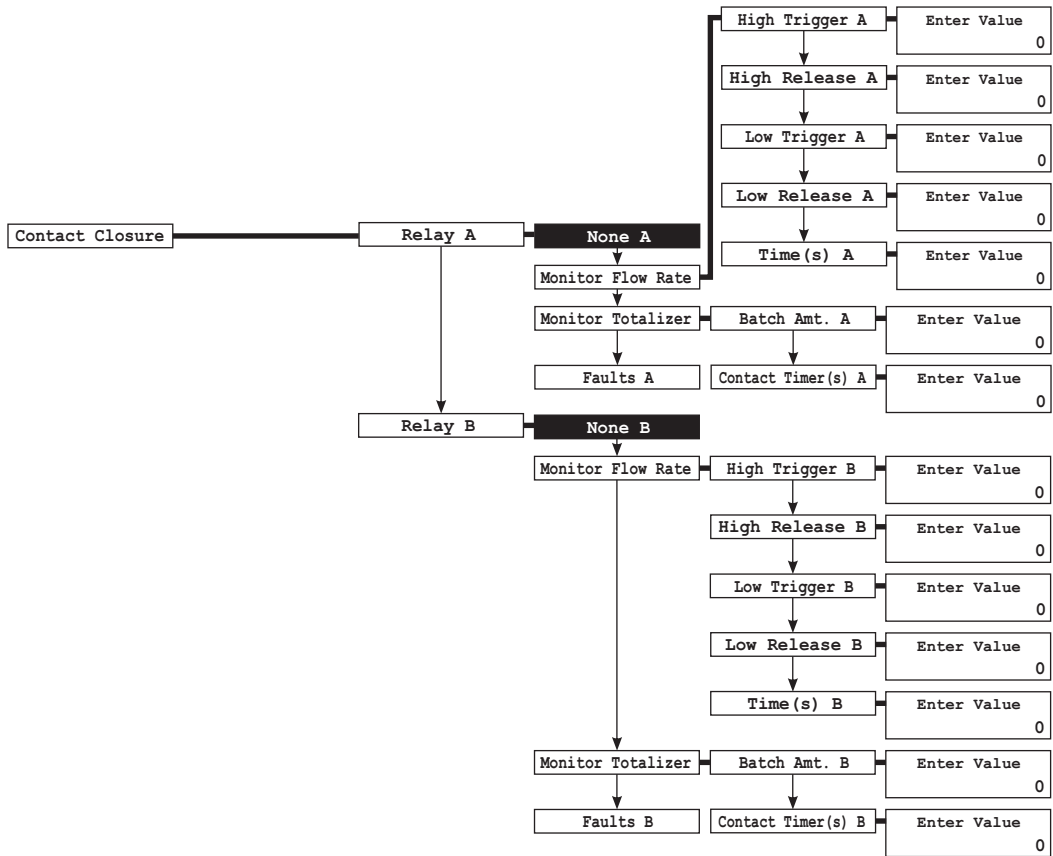

6.4.3.1 CC Assigned to Monitor Flow Rate

When in the **Relay A** or **Relay B** menu, selecting and then exiting the **Monitor Flow Rate** menu will assigned that relay to monitor the rate of flow. The following functions are possible:

- Set a **High Trigger** flow rate value which when measured, will energize the relay.
- Set a **High Release** flow rate value which when measured, will de-energize the relay.
- Set a **Low Trigger** flow rate value which when measured, will energize the relay.
- Set a **Low Release** flow rate value which when measured, will de-energize the relay.
- Set a **Time (s)** in seconds (0-999) to delay energizing the relay when it is triggered.

When either of the relays are energized, the display back-light will turn blue.

When both the trigger and release values are configured for the same value, the relay will latch. The user must press the **ESC** button to clear a latched relay.

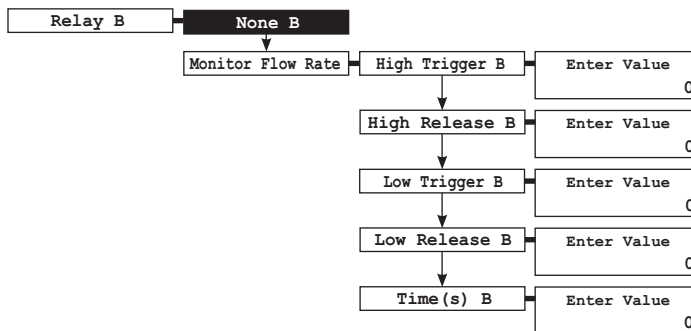

6.4.3.1
CC Assigned to
Monitor Totalizer

When in the **Relay A** or **Relay B** menu, selecting and then exiting the **Monitor Totalizer** menu will assigned that relay to monitor the accumulated to flow value. The following functions are possible:

- Set a **Batch Amount** total flow value which when reached, will energize the relay.
- Set the **Contact Timer(s)** for the number of seconds (0-999) that the relay will remain energized.

When either of the relays are energized, the display back-light will turn blue.

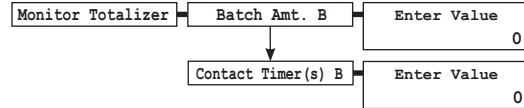

6.4.3.2
CC Assigned to
Monitor FAULTS

When in the **Relay A** or **Relay B** menu, selecting and then exiting the **FAULTS** menu will assign that relay to energize when any of the following fault conditions exist.

- **FAULT 11** - Transducers are not connected or there is no fluid in the pipe.
- **FAULT 12** - The allowable SOS (Speed Of Sound) error set-point has been exceeded.
- **FAULT 21** - The configuration data is not valid.

The display back-light will turn red when there is a FAULT condition.

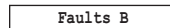

6.4.4
Anybus
Comm.
Menu

There are five different **Anybus** communications modules that can be installed in the S4 meter. Each optional module uses a different communications protocol.

Anybus Communications Options		
Protocol	Network Connector	Baud Rate
Profibus DPV	DB9F	Up to 12 Mbit/s
Modbus RTU	DB9F	Up to 12 Mbit/s
Modbus TCP	RJ45	10/100 Mbit/s full/half duplex
Industrial Ethernet/IP	RJ45	10/100 Mbit/s full/half duplex
Profinet IO	RJ45	100 Mbit/s full duplex

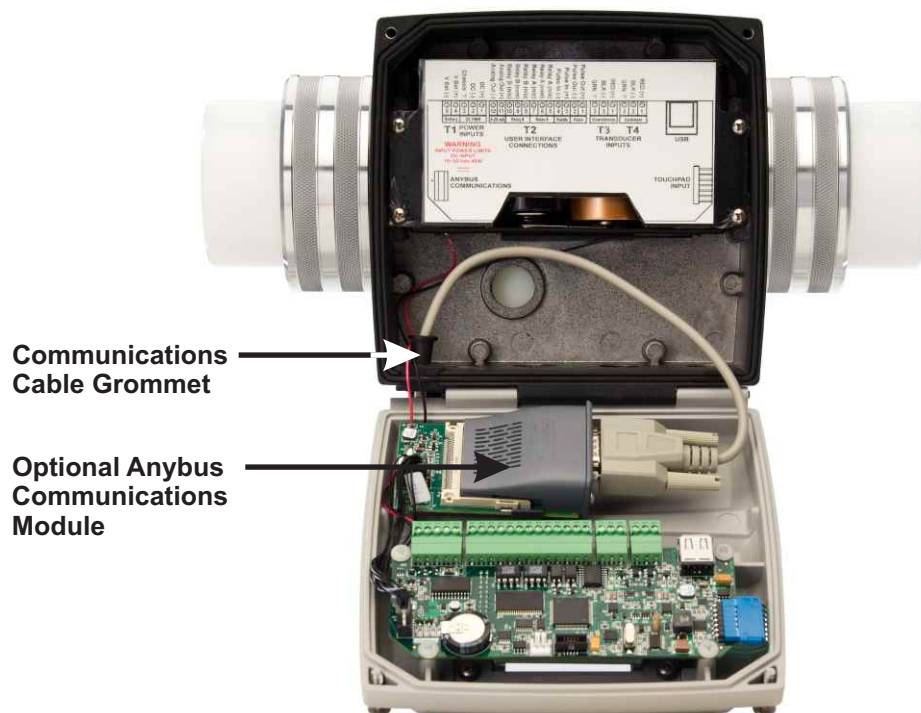

Select the module being used and enter the **Port Address** (for Profibus DPV or Modbus RTU modules) or the **IP ADDRESS** (for Modbus TCP, Industrial Ethernet/IP or Profinet IO modules).

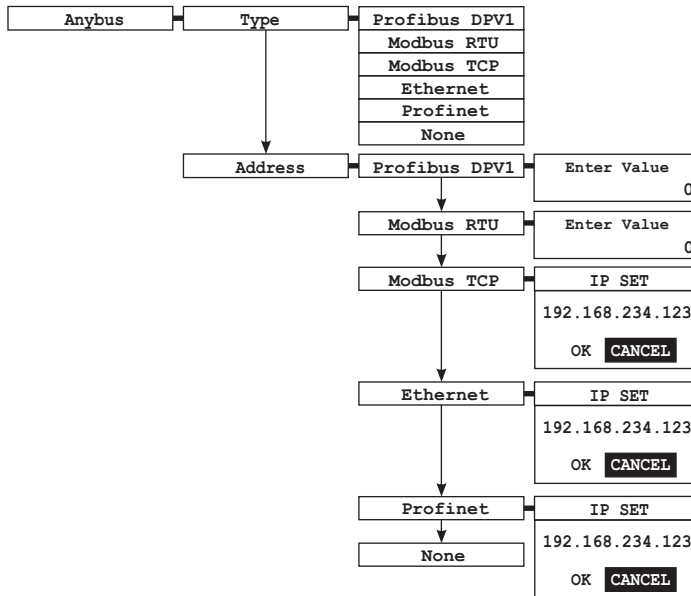

Use the following Anybus mapping structure to communicate with the module and monitor the flowmeter. There are no send commands available.

Byte	Bit		Type	No. of Bytes	Description
1	0	Contact Closure 1		1	0: CC OFF, 1:CC ON 0: CC OFF, 1:CC ON
	1	Contact Closure 2			
	2	Reserved			
	3	Reserved			
	4	Reserved			
	5	Reserved			
	6	Reserved			
	7	Reserved			
2	0	Reserved		1	
	1	Reserved			
	2	Reserved			
	3	Reserved			
	4	Reserved			
	5	Reserved			
	6	Reserved			
	7	Reserved			
3		Flow Rate	double	8	Current flow rate value.
11		Totalizer	double	8	Current totalizer value.
19		Fault Number Table	char	6	Fault number table upto six faults.
25		Speed of Sound	unsigned long	8	Current SOS value.
33		Goodness Of Meas.	unsigned char	1	Current GOM - 1 to 4.
34		Reserved	unsigned char	1	
35		4 - 20mA Flow	unsigned char	1	4 to 20mA current output
36		Reserved	unsigned char	1	
37		Flow Frequency	unsigned char	8	Frequency output
45		Firmware Version	unsigned char	8	8 ASCII characters. A11.22.33
53		Log Entry	unsigned char	86	Log Entry String Eg: 2013/12/29 09:15:00 FR 0.0000 TL 0.00

6.5 Configure the Clock

In the **Clock** menu, use the right arrow ► or left arrow ◀ to highlight the Year, Month, Day, hour, or minute. Change the highlighted value using the up arrow ▲ or down arrow ▼ button. To save the entries, highlight **OK** and press **ENTER**.

The clock is powered by a supercapacitor, which is continuously charging while the meter is powered, rather than a battery. It never has to be replaced.

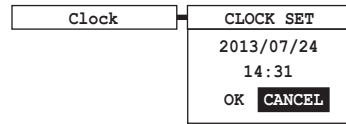

6.6 Zero Flow Calibration

The zero calibration data can be stored for one flow direction only. If the **Pipe Fitting** and **SPU** was shipped from the factory as a single model number, the zero flow **Calibration** required to link the SPU and the Pipe Fitting was performed at the factory for the A → B flow direction. No further calibration is necessary. If the flow direction is from A ← B or if a new **Ultrasonic Inline Pipe Fitting** is used, re-calibration may be necessary to achieve high accuracy.

The meter can be re-calibrated in the field by selecting **Calibration** and pressing the right arrow ► or **ENTER** button. The pipe must be full of fluid and there must be no movement of the fluid in the pipe during the calibration process.

Note that performing a **Zero Flow Calibration** does not affect the Flow Direction configuration settings shown on the Calibration Detail Label: **Zero** and **Zero +/-** variables: transducer/Flow Direction/Settings/A → B/

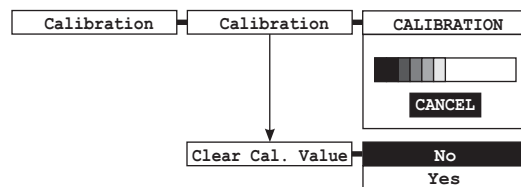

6.7 Global Configuration

In the **Global Config.** menu, the user can configure a password, restore the factory default configuration data, save and restore configuration data to a USB thumb drive, and update or view the current firmware version.

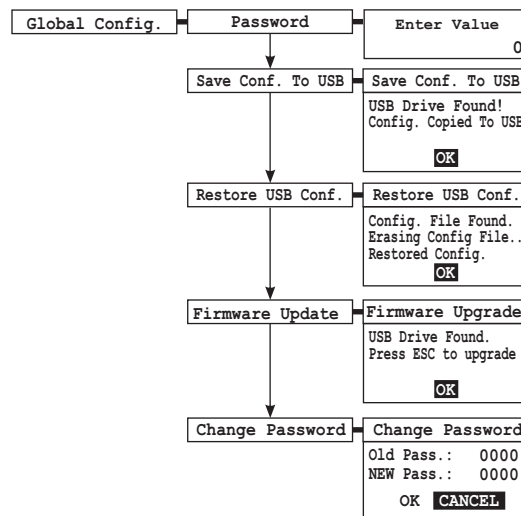

6.7.1 Password

The S4 is shipped from the factory with the default password 0000. If a new password is not configured, the meter will allow saving changes to the configuration at the main menu.

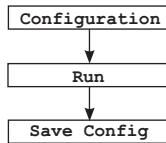

A user defined four digit password can be entered to replace 0000.

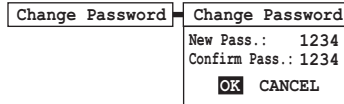

Once a new password has been configured, it must be entered to allow saving any changes made to the configuration data. Once entered, the **Save Config** function is possible at the main menu.



Once entered, the user defined password can be changed to any four digit number.

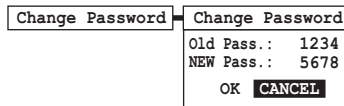

Enter master password 3408 to clear any stored password.

6.7.2 Save/Restore Config

The S4 configuration settings can be save and restored using a USB flash drive.

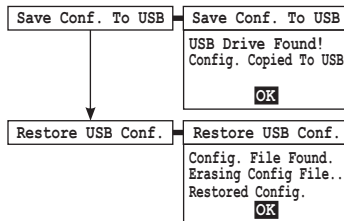

6.7.3 Firmware Update

The S4 firmware can be upgraded to the latest version. Download from www.blue-white.com to a USB flash drive.

Configuration data will not be erased.

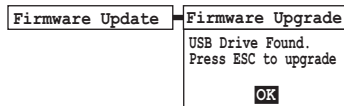

7.0 Specifications

General Operation

Measuring Principle

Ultrasonic - Transit Time.

Fluid Types

Water to 5% (0 to 50,000 ppm) particulate.

Fluid Velocity Range

0.5 to 30 feet per second (0.15 to 9 meters per second)

Nominal Pipe Sizes

0.50, 0.75, 1.00, 1.50 and 2 inch IPS pipe sizes

Accuracy

+/-2% of rate > 1 ft/sec, +/-0.10 ft/sec < 1 ft/sec

Inline Pipe Fitting/ Transducer

Pipe Fitting/Transducer

NEMA 4X (IP66), High Density Polyethylene

Connection option A -

High Density Polyethylene, Female NPT threads
Maximum fluid temperature: 14°F to 160°F (-10°C to 71°C)

Maximum operating pressure: 300 PSI/g at 70°F

Connection option B -

316 Stainless Steel, Female NPT threads
Maximum fluid temperature: 14°F to 160°F (-10°C to 71°C)

Maximum operating pressure: 300 PSI/g at 70°F

Connection option C -

PVC, Female Slip
Maximum fluid temperature: 14°F to 140°F (-10°C to 60°C)

Maximum operating pressure: 300 PSI/g at 70°F

Connection option D -

316 Stainless Steel, 150# Flat Face Flange (without gaskets)
Maximum fluid temperature: 14°F to 160°F (-10°C to 71°C)

Maximum operating pressure: 300 PSI/g at 70°F

Cable - field replaceable

Shielded coaxial RG/U Type: 59. FEP jacket, black. RoHS Compliant

Connector: thermoplastic locking. NEMA 4X (IP66)

Available lengths: 10ft (3m), 25 ft. (7m), 50 ft. (15m), 100 ft. (30m)

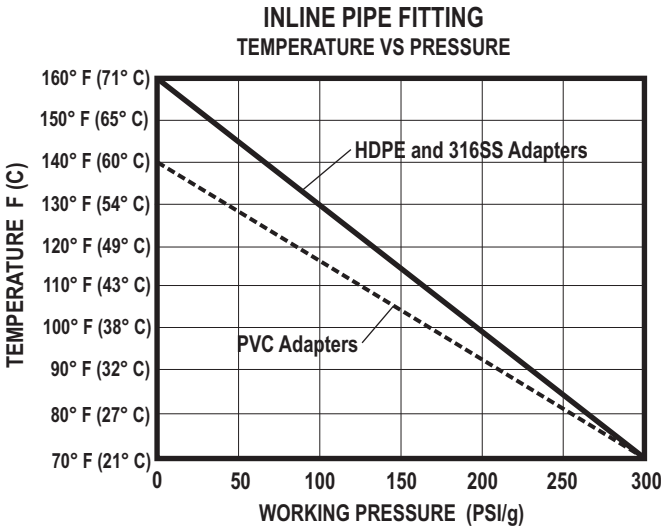

FLOW RANGES			
Model Number	Pipe Size	Min. Flow (0.5 fps) GPM (LPM)	Max. Flow (30 fps) GPM (LPM)
05	1/2"	0.36 (1.36)	21.9 (82.9)
07	3/4"	0.67 (2.54)	40.4 (153)
10	1"	1.12 (4.24)	67.3 (255)
15	1-1/2"	2.75 (10.4)	165 (625)
20	2"	4.60 (17.4)	276 (1045)

SPU (Signal Processing Unit)

Enclosure

NEMA 4X (IP66), Powder coated aluminum, SS clamps and hardware.
Dimensions: 7.24H x 6.69W x 3.11D inches (184H x 170W x 79D mm)
Weight 3.7 lb. (1.7 Kg.)

Mounting

Pipe fitting, wall or pipe (vertical or horizontal) mounting. Hardware included.

Power Requirements

15-28 VDC; 15 watts maximum

Operating Temperature

14°F to 140°F (-10°C to 60°C) **Storage:** -40°F to 158°F (-40°C to 70°C)

Display

VGA backlit LCD, UV resistant.
Simultaneous Rate and Total: 8 digit maximum
Decimal location configurable to 5 places.

Display Language

English

Keypad

Six-button positive action tactile switch keypad.

Security

Programmable 4-digit password.

Display Volume Units

Independently configurable Rate and Total display units in: U.S. Gallons, ounces, barrels (US liquid), barrels (US oil), cubic ft, acre ft, Imperial (British) gallons, liter, cubic meter, or user defined "custom" units.
Rate display in feet or meters per second.

Display Time Units

Seconds, minutes, hours, days.

Display/Output Response Time

1.0 second.

Flow Rate Display Averaging

Selectable: 0.50, 1.0, 2.5, 5.0 (default), 10.0 seconds.

Data Outputs

- Isolated 4-20 mA output - fully configurable, invertible
- 0-1000 Hz Pulse output - fully configurable, invertible

Data Logging

Date/time stamped flow rate and flow total data in FAT32 file format, easily imported into Excel. Configurable to trigger on time interval (1-999,999 sec), rate and/or total set-point values. Store up to 191,800 log events in the memory buffer, downloadable to flash memory via USB port.

Process Control

Two independently configurable relays.

Type: FORM C

Load capacity: 30V, 100mA max (ext. supplied)

- Configure to flow rate for high/low/range rate alarm. Programmable release values enable auto release or manual latching operation.
- Configure to flow total for automatically triggered, timed batch operations for proportional feed applications.

External Communications

Computer connection via optional **Communications Modules:**

- Industrial Ethernet/IP
- Modbus RTU
- Modbus TCP
- Profinet RT/IO
- Profibus DPV1

When equipped with a communications module, the following data transfer is possible:

1. Flow rate
2. Flow total
3. Fault/warning codes
4. Log data
5. CC1 relay status
6. CC2 relay status
7. Current fluid sound speed
8. Number of Goodness of Measurement boxes filled in
9. Analog output value (4-20 mA)
10. Frequency output value (0-1000 Hz)
11. Firmware version

7.1 Model Number System

Sonic-Pro S4 Part Number Matrix									
Signal Processing Unit (SPU) - Display									
S4	Sonic-Pro Base model								
Communications Options									
D	Industrial Ethernet/IP								
E	Modbus RTU								
F	Modbus TCP/IP								
G	PROFINET RT/I/O								
H	PROFIBUS-DPV1								
X	Standard 4-20mA and High Speed Pulse output only								
Input Power (15 - 30 VDC required - all units include D cell battery pack, 4 D cell batteries are not included)									
0	Without power supply (customer supplies 15-30 VDC)								
1	U.S. 115VAC~50/60 / 15VDC plug-in transformer								
2	Europe 220VAC~50/60 / 15VDC plug-in transformer								
3	U.S. 230VAC~50/60 / 15VDC plug-in transformer								
Inline Pipe Fitting/Transducer									
C	Inline pipe fitting/transducer (see pipe size and material options below)								
X	Without inline pipe fitting/transducer								
Transducer Cable Length and Connection Type									
A	10 ft cable length - with field replaceable liquid-tight cable plug and socket								
B	25 ft cable length - with field replaceable liquid-tight cable plug and socket								
C	50 ft cable length - with field replaceable liquid-tight cable plug and socket								
D	100 ft cable length - with field replaceable liquid-tight cable plug and socket								
X	Display mounted directly on the inline pipe fitting/transducer - no transducer cables								
Z	Inline pipe fitting transducer only (no display) - without cables								
Inline Pipe Fitting/Transducer									
Fluid Sound Speed Working Range									
0	Water like fluids 1500 +/- 100 m/sec								
Nominal IPS Pipe Connection Size									
05	1/2"	07	3/4"	10	1"	15	1-1/2"	20	2"
Pipe Connection Type and Material									
A	F/NPT, HDPE	B	F/NPT, 316SS	C	Slip, PVC	D	Flange, 316SS		
Inline Body Material									
G	Polyethylene (HDPE)								
S4	D	1	C	A	0	07	A	G	Sample Part Number

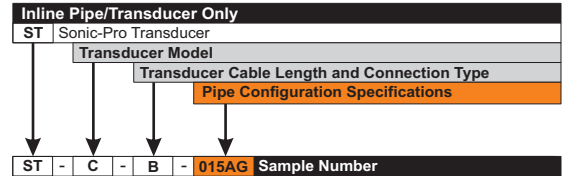

7.2 Sound speed data

Water Sound Speeds

Temp °C	Temp °F	Sound Speed (meters/sec)
0	32	1403
5	41	1427
10	50	1447
20	68	1481
30	86	1507
40	104	1526
50	122	1541
60	140	1552
70	158	1555
80	176	1555
90	194	1550
100	212	1543

7.3 Dimensional Drawings

Sonic-Pro SPU

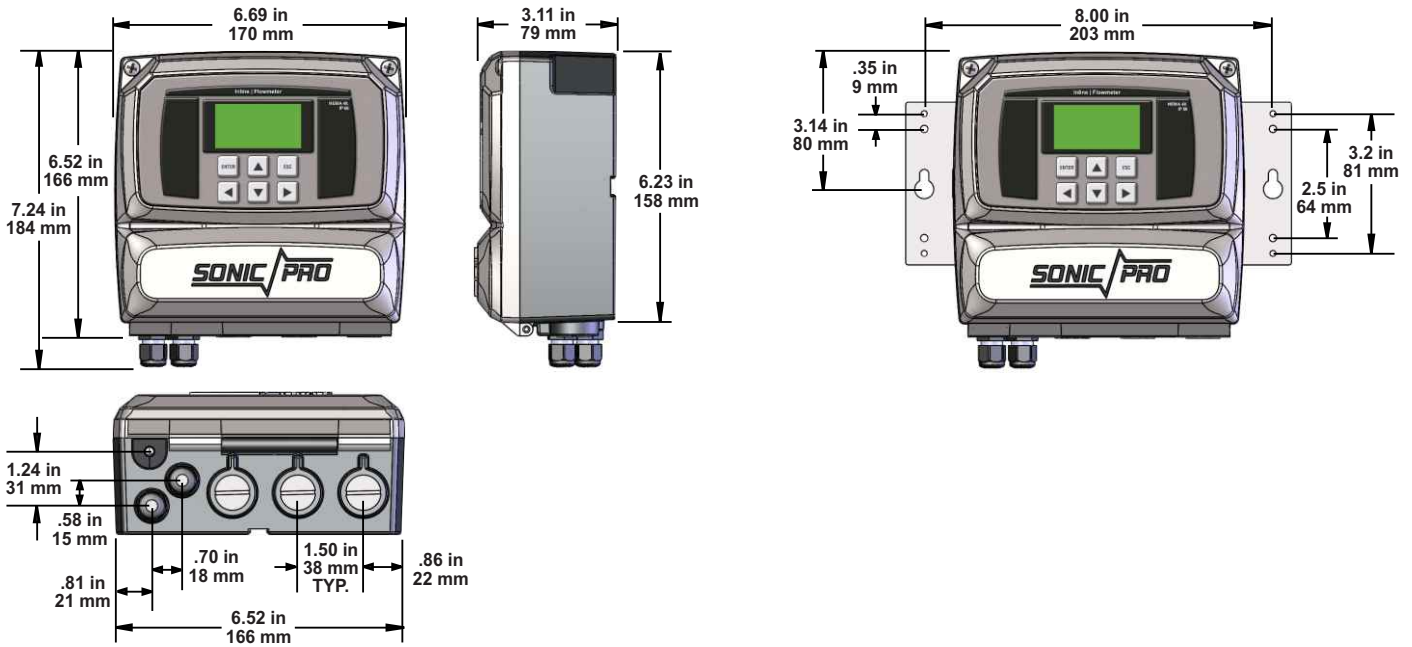

Sonic-Pro Inline Pipe Fittings

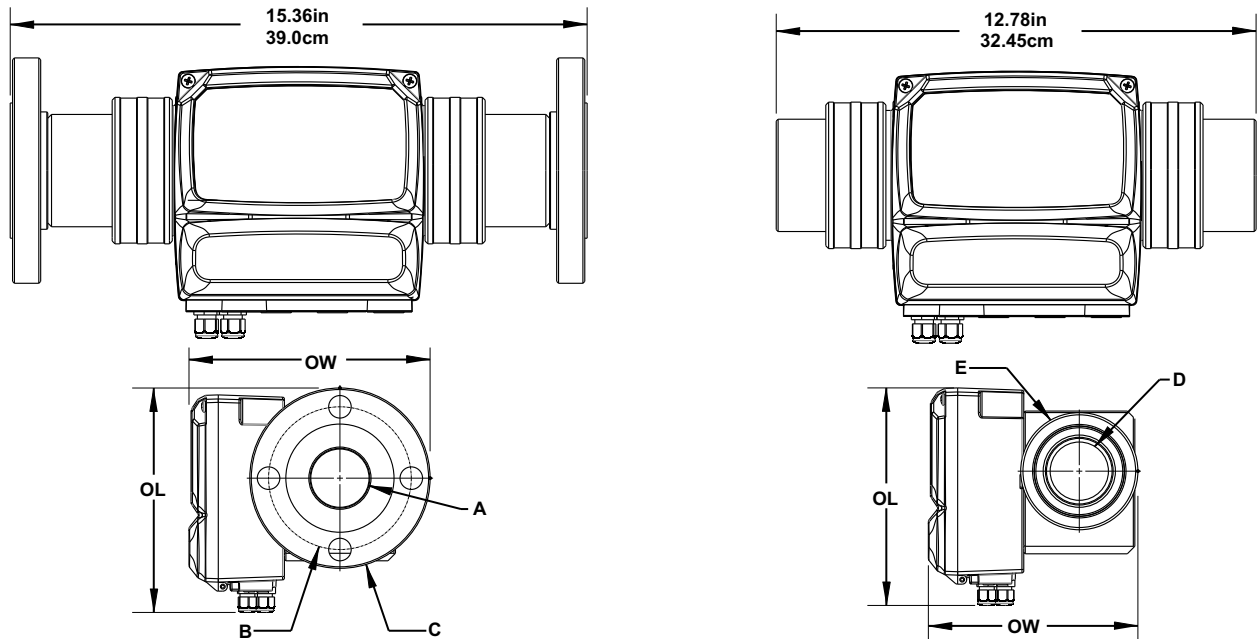

Flanged Fittings					
Pipe Size	OL	OW	A	B	C
2"	7.47in [18.97cm]	8.02in [20.38cm]	1.94in [4.93cm]	4.75in [12.07cm]	6.00in [15.24cm]
1.5"	7.24in [18.39cm]	7.35in [18.68cm]	1.50in [3.81cm]	3.88in [9.86cm]	5.00in [12.70cm]
1"	7.24in [18.39cm]	6.76in [17.18cm]	.96in [2.45cm]	3.12in [7.92cm]	4.25in [10.80cm]
.75"	7.24in [18.39cm]	6.45in [16.45cm]	.74in [1.88cm]	2.75in [6.99cm]	3.88in [9.86cm]
.5"	7.24in [18.39cm]	6.20in [15.75cm]	.55in [1.39cm]	2.38in [6.05cm]	3.50in [8.89cm]

NPT Fittings				
Pipe Size	OL	OW	D	E
2"	7.24in [18.39cm]	6.97in [17.71cm]	1.94in [4.93cm]	3.90in [9.91cm]
1.5"	7.24in [18.39cm]	6.53in [16.59cm]	1.50in [3.81cm]	3.33in [8.45cm]
1"	7.24in [18.39cm]	5.98in [15.18cm]	.96in [2.45cm]	2.75in [6.99cm]
.75"	7.24in [18.39cm]	5.90in [14.97cm]	.74in [1.88cm]	2.75in [6.99cm]
.5"	7.24in [18.39cm]	5.83in [14.80cm]	.55in [1.39cm]	2.75in [6.99cm]

7.4 Menu Flow Chart

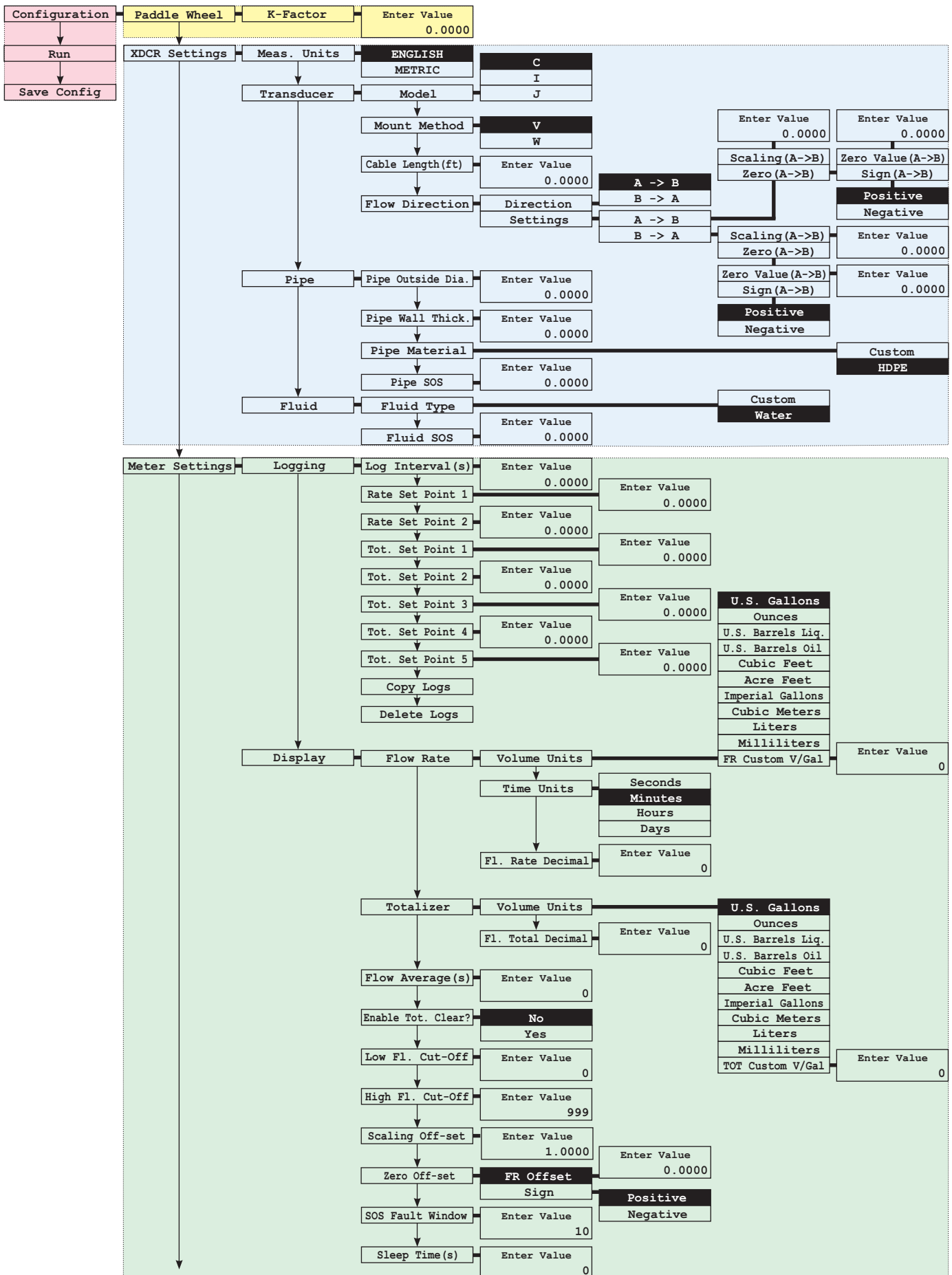

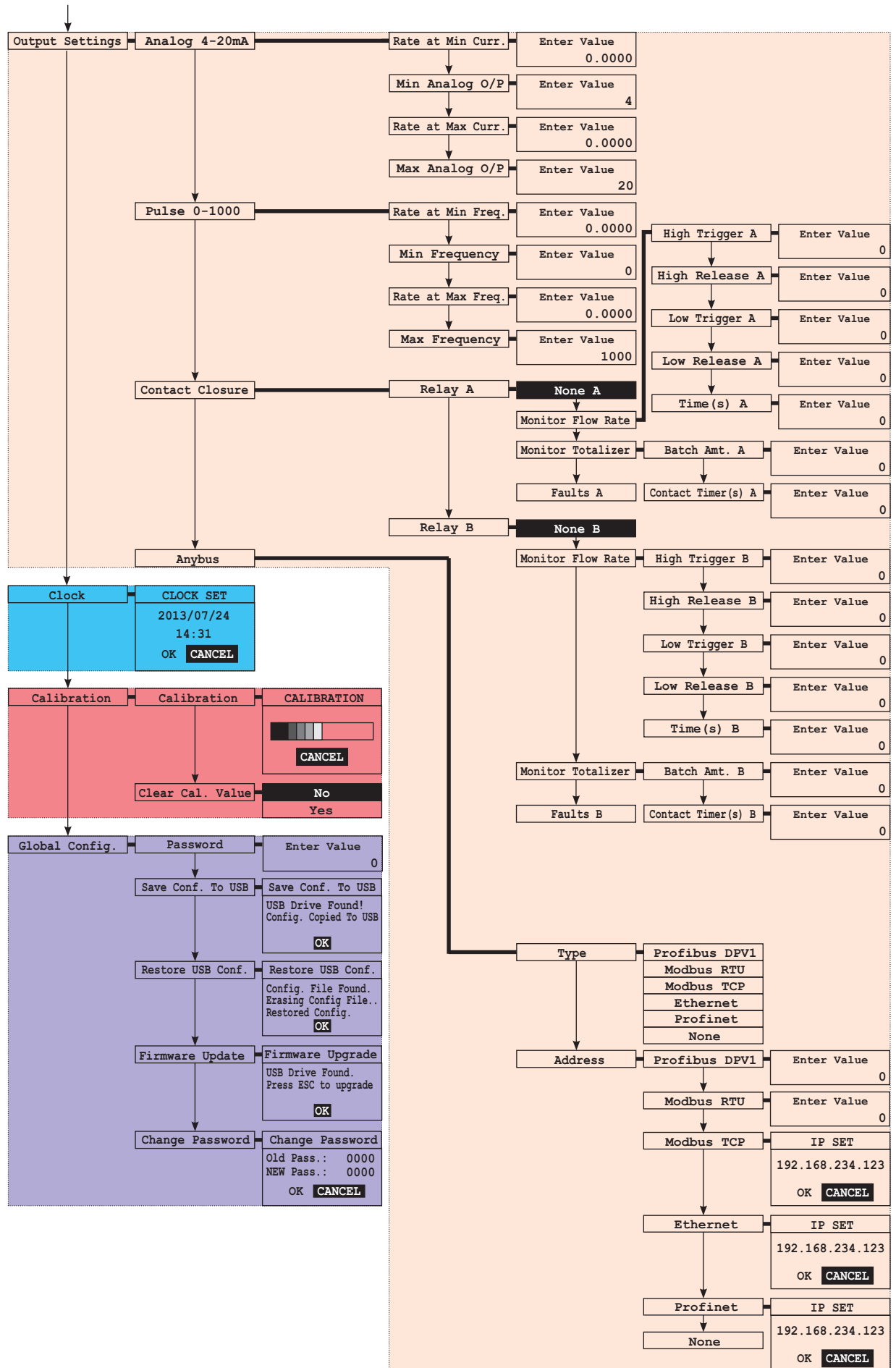

Limited Warranty

- Blue-White Sonic-Pro flowmeters are warranted to be free from defects in material and workmanship for 24 months from date of factory shipment. WARRANTY COVERAGE IS LIMITED TO REPAIR OR REPLACEMENT OF THE DEFECTIVE FLOWMETER ONLY. UNDER NO CIRCUMSTANCES SHALL BLUE-WHITE BE LIABLE FOR ANY CONSEQUENTIAL OR INCIDENTAL LOSSES OR DAMAGES THAT SHOULD ARISE FROM THE USE OF THE FLOWMETER AND IN NO EVENT SHALL THE COMPANIES LIABILITY EXCEED THE PURCHASE PRICE PAID BY THE PURCHASER FOR THE PRODUCT.
- This warranty does not cover damage to the flowmeter that results from misuse or alterations, nor damage that occurs as a result of improper installation.
- Blue-White assumes no liability for the acceptability of the flowmeter in a specific application. THE USER MUST DETERMINE THE ACCEPTABILITY OF THE PRODUCT AND ITS FITNESS FOR USE IN THE SPECIFIC APPLICATION.
- Flowmeters are repaired at the factory only. Call or write the factory to receive a RMA (return materials authorization) number. Carefully pack the flowmeter to be returned and write the RMA number on the outside of the shipping carton. Include a brief description of the problem and the application.
- Prepay all shipping costs. The factory does not accept C.O.D. Shipments. Damage that occurs during shipping is the responsibility of the sender.



Users of electrical and electronic equipment (EEE) with the WEEE marking per Annex IV of the WEEE Directive must not dispose of end of life EEE as unsorted municipal waste, but use the collection framework available to them for the return, recycle, recovery of WEEE and minimize any potential effects of EEE on the environment and human health due to the presence of hazardous substances. The WEEE marking applies only to countries within the European Union (EU) and Norway. Appliances are labeled in accordance with European Directive 2002/96/EC. Contact your local waste recovery agency for a *Designated Collection Facility* in your area.



ProSeries™
by Blue-White Ind.

5300 Business Drive, Huntington Beach, CA 92649 USA

Phone: 714-893-8529 **FAX:** 714-894-9492

E mail: sales@blue-white.com **or** techsupport@blue-white.com **URL:** www.blue-white.com